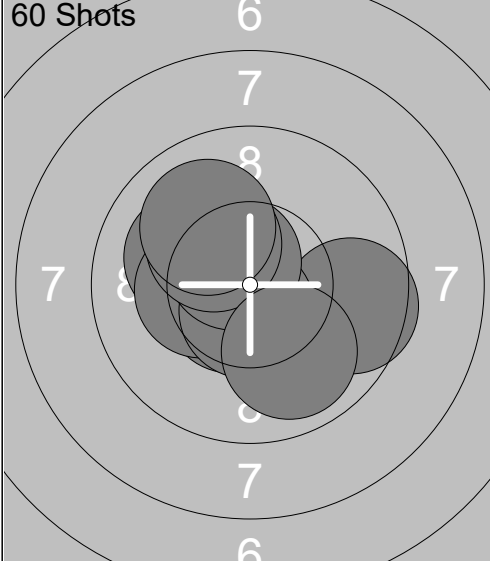
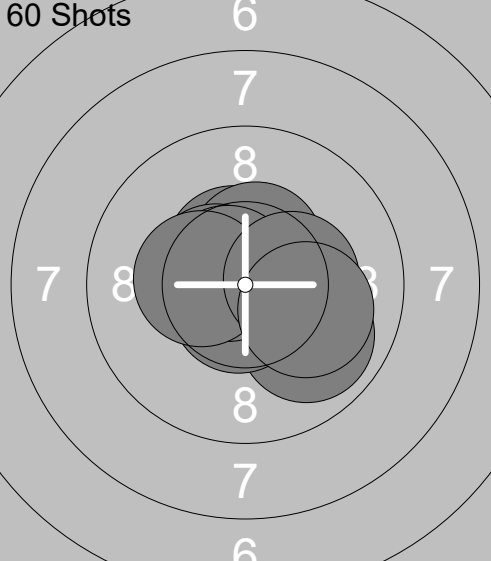
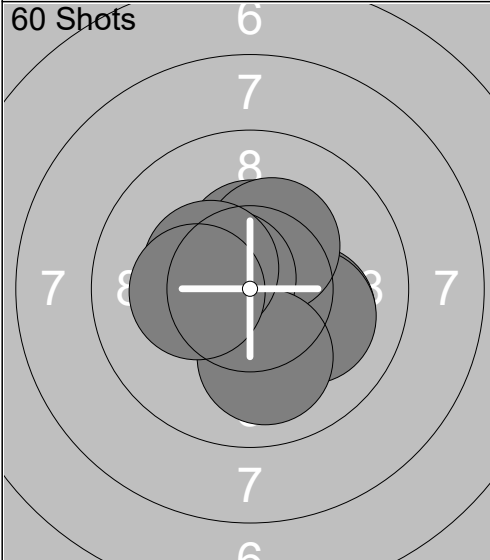
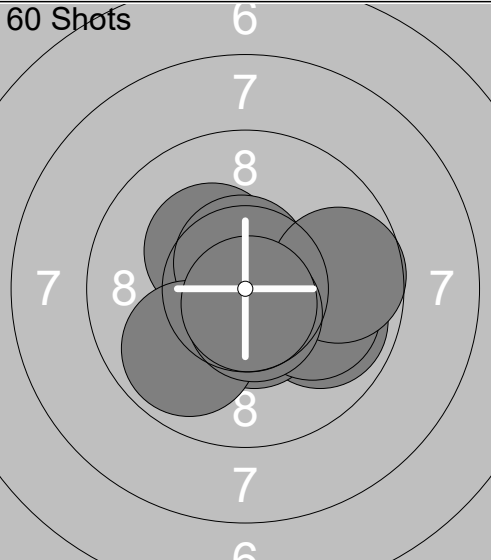
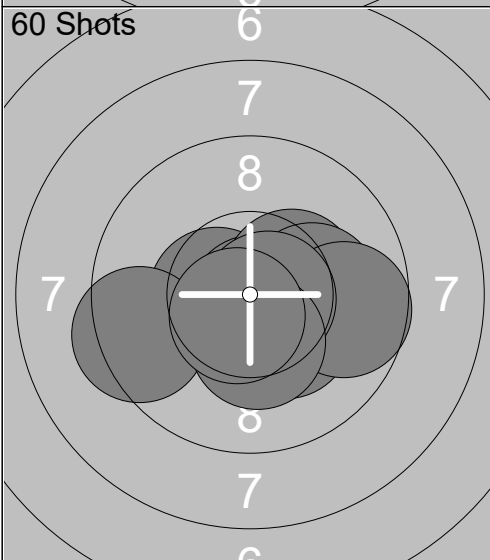
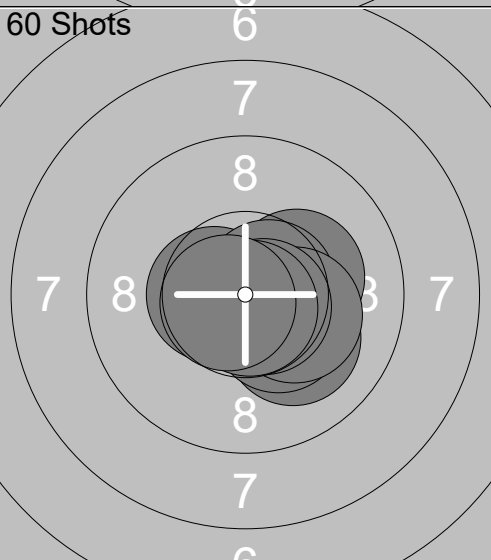
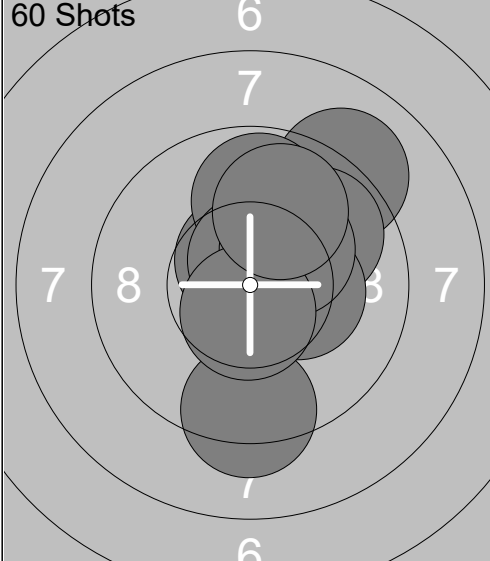
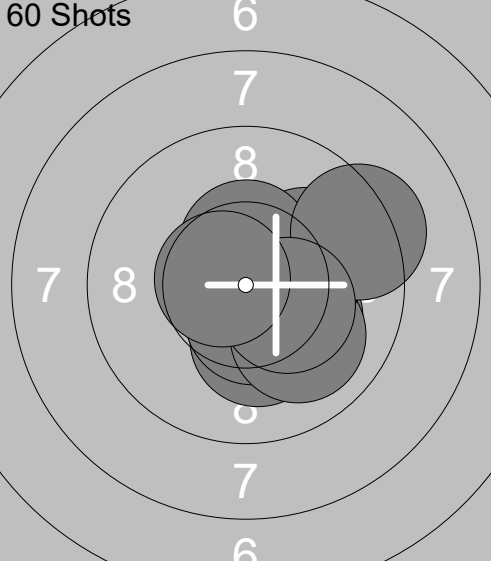
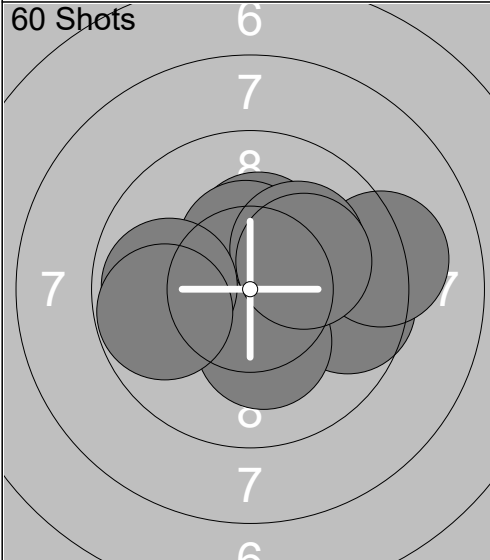
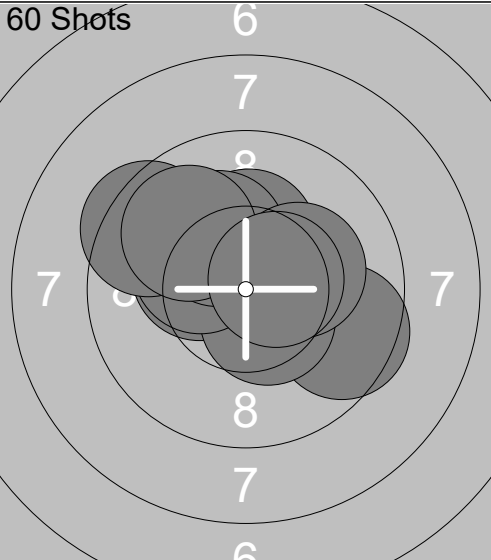
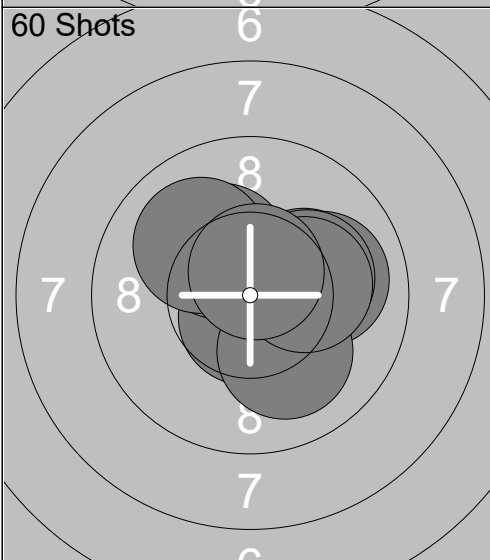
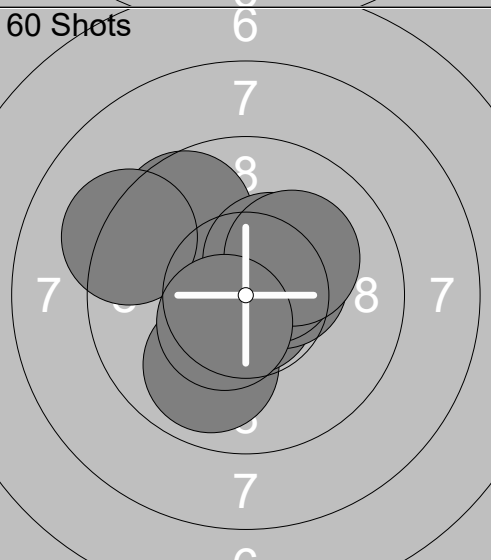
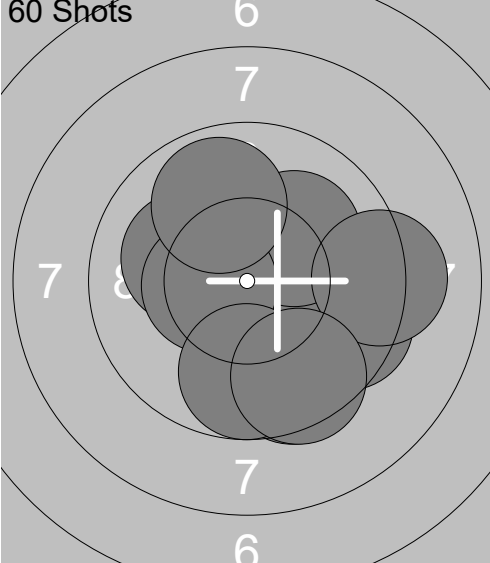
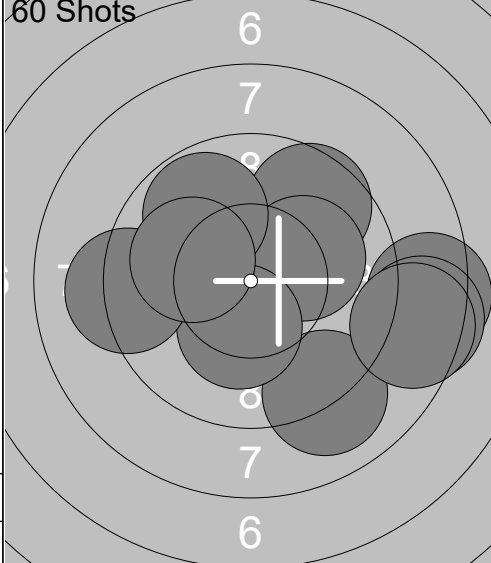
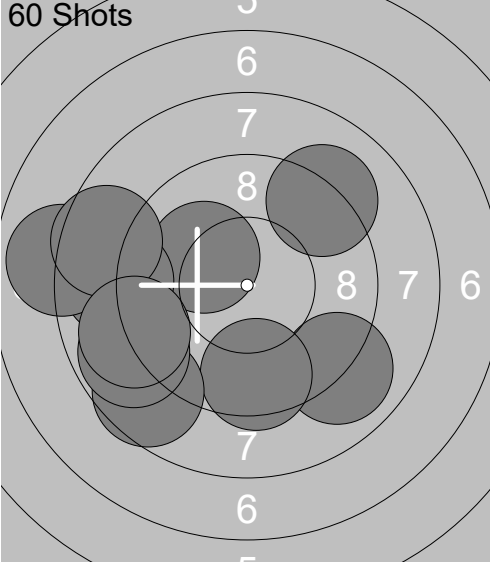
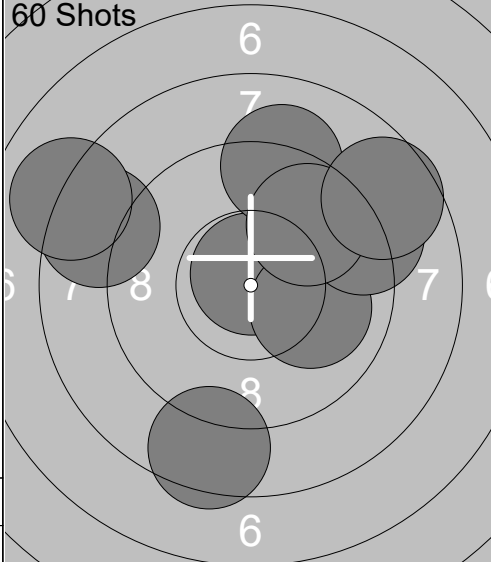
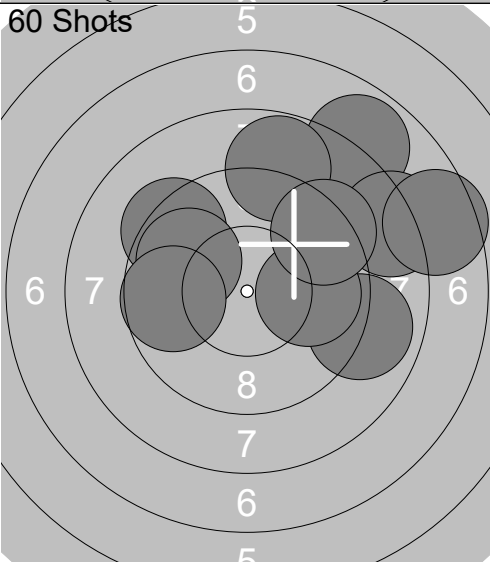
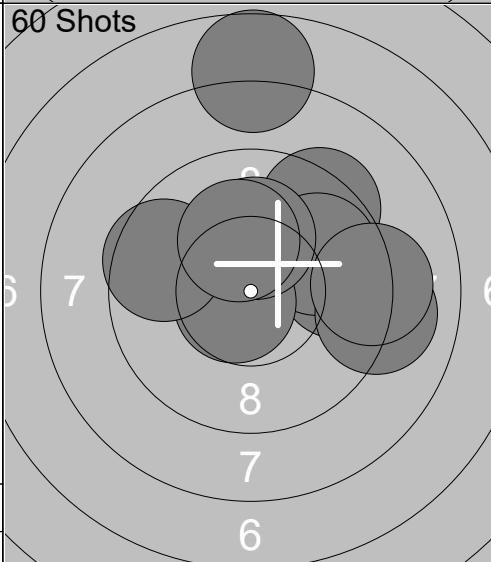

<p>60 Shots</p> 	<p>1: 10.1 ↖ 2: 10.6x ← 3: 9.6 → 4: 10.6x ↙ 5: 10.3x ← 6: 10.6x ↓ 7: 10.6x ↗ 8: 10.2x ↗ 9: 10.0 ↗ 10: 9.9 ↘</p> <p>Series 102.5 102.5</p>	<p>60 Shots</p> 	<p>11: 9.9 ↘ 12: 10.8x → 13: 10.5x ↑ 14: 10.5x ↑ 15: 10.7x ↓ 16: 10.5x ↖ 17: 10.7x ↖ 18: 10.4x ← 19: 10.3x → 20: 10.1 →</p> <p>Series 104.4 206.9</p>
<p>60 Shots</p> 	<p>21: 10.4x ↑ 22: 10.6x ← 23: 10.6x ↗ 24: 10.1 → 25: 10.1 → 26: 10.3x ↗ 27: 10.6x ↖ 28: 10.0 ↓ 29: 10.4x ↖ 30: 10.3x ←</p> <p>Series 103.4 310.3</p>	<p>60 Shots</p> 	<p>31: 10.3x ↗ 32: 10.7x → 33: 9.9 → 34: 10.6x ↑ 35: 10.5x ↓ 36: 10.0 → 37: 9.9 ↙ 38: 9.7 → 39: 10.6x ↓ 40: 10.7x ↓</p> <p>Series 102.9 413.2</p>
<p>60 Shots</p> 	<p>41: 10.5x ← 42: 10.3x ↘ 43: 10.8x ↘ 44: 10.4x → 45: 10.1 → 46: 9.4 ← 47: 9.7 → 48: 10.7x → 49: 10.3x ↓ 50: 10.6x ↙</p> <p>Series 102.8 516.0</p>	<p>60 Shots</p> 	<p>51: 10.5x ← 52: 10.7x → 53: 10.1 ↘ 54: 10.2x → 55: 10.6x → 56: 10.3x ↘ 57: 10.2x → 58: 10.7x ↘ 59: 10.8x ↓ 60: 10.7x ↖</p> <p>Series 104.8 620.8</p>

<p>60 Shots</p> 	<p>1: 9.1 ↗ 2: 10.6x ↖ 3: 9.8 ↑ 4: 10.6x ↑ 5: 9.3 ↓ 6: 9.8 ↗ 7: 10.3x → 8: 10.3x ↗ 9: 10.6x ↓ 10: 9.9 ↑</p> <p>Series 100.3 100.3</p>	<p>60 Shots</p> 	<p>11: 10.2x ↓ 12: 10.2x ↘ 13: 10.5x ↓ 14: 10.0 ↘ 15: 10.2x → 16: 10.1 → 17: 10.5x ↑ 18: 9.3 → 19: 10.3x ↘ 20: 10.6x ←</p> <p>Series 101.9 202.2</p>
<p>60 Shots</p> 	<p>21: 9.5 → 22: 9.6 → 23: 10.3x ↑ 24: 10.4x ↑ 25: 9.2 → 26: 10.2x ↓ 27: 10.1 ↗ 28: 10.1 ↗ 29: 9.9 ← 30: 9.8 ←</p> <p>Series 99.1 301.3</p>	<p>60 Shots</p> 	<p>31: 9.6 ↘ 32: 10.3x ↑ 33: 10.3x ← 34: 10.5x ↘ 35: 10.3x ← 36: 10.2x ↖ 37: 10.2x → 38: 9.4 ↖ 39: 9.9 ↖ 40: 10.5x →</p> <p>Series 101.2 402.5</p>
<p>60 Shots</p> 	<p>41: 10.2x → 42: 10.6x ↗ 43: 10.7x ↓ 44: 10.3x ↖ 45: 10.0 ↖ 46: 10.0 → 47: 10.2x → 48: 10.1 ↓ 49: 10.2x → 50: 10.6x ↑</p> <p>Series 102.9 505.4</p>	<p>60 Shots</p> 	<p>51: 10.6x ↖ 52: 9.9 ↓ 53: 10.8x ↓ 54: 10.5x → 55: 10.5x ↗ 56: 9.7 ↖ 57: 10.4x ↗ 58: 9.2 ↖ 59: 10.2x ↗ 60: 10.5x ↘</p> <p>Series 102.3 607.7</p>

<p>60 Shots</p>  <p style="text-align: center;">Series 97.7</p>	<p>1: 10.1 ↖</p> <p>2: 9.6 ↘</p> <p>3: 9.7 ➡</p> <p>4: 9.5 ➡</p> <p>5: 10.1 ↗</p> <p>6: 9.2 ➡</p> <p>7: 10.4x ←</p> <p>8: 9.7 ↘</p> <p>9: 9.5 ↘</p> <p>10: 9.9 ↗</p> <p style="text-align: center;">Series 97.7</p>	<p>60 Shots</p>  <p style="text-align: center;">Series 93.6</p>
<p>60 Shots</p>  <p style="text-align: center;">Series 89.5</p>	<p>21: 9.0 ↘</p> <p>22: 9.5 ↘</p> <p>23: 8.6 ↘</p> <p>24: 10.1 ↖</p> <p>25: 8.9 ←</p> <p>26: 8.8 ←</p> <p>27: 7.9 ←</p> <p>28: 8.6 ←</p> <p>29: 9.1 ↗</p> <p>30: 9.0 ←</p> <p style="text-align: center;">Series 89.5</p>	<p>60 Shots</p>  <p style="text-align: center;">Series 92.1</p>
<p>60 Shots</p>  <p style="text-align: center;">Series 89.4</p>	<p>41: 9.3 ↖</p> <p>42: 9.8 ↖</p> <p>43: 7.9 ↗</p> <p>44: 8.8 ↗</p> <p>45: 8.3 ➡</p> <p>46: 8.9 ➡</p> <p>47: 9.9 ➡</p> <p>48: 9.3 ↗</p> <p>49: 7.5 ➡</p> <p>50: 9.7 ←</p> <p style="text-align: center;">Series 89.4</p>	<p>60 Shots</p>  <p style="text-align: center;">Series 95.5</p>
462.3	191.3	557.8

Relay 2	Lane 13	Riley Dunn
-------------------	-------------------	-------------------

WVU Mobile Range		
------------------	--	--

18.11.2023	Walther Cup 2023	West Virginia University
------------	------------------	--------------------------

Comment	Signature
---------	-----------

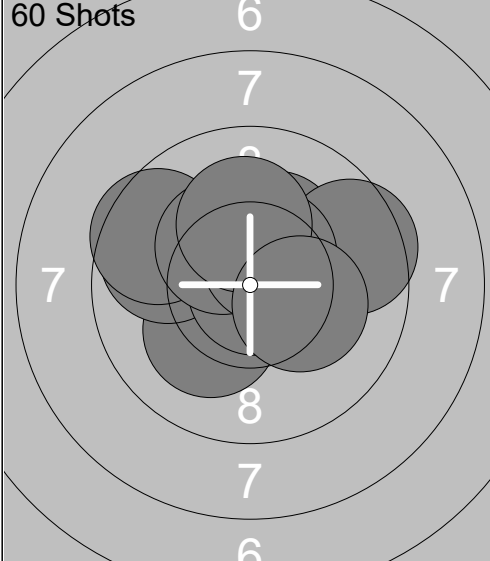
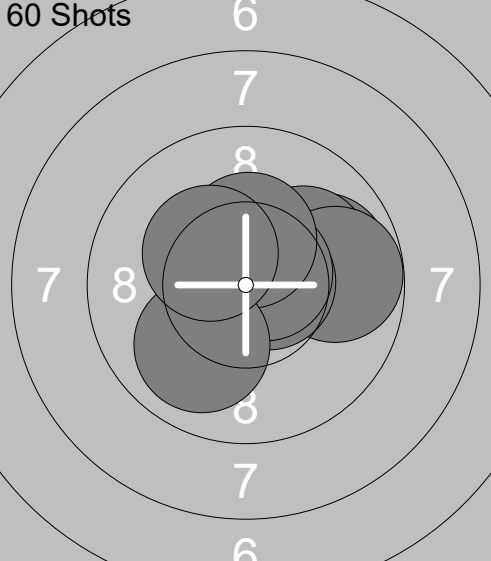
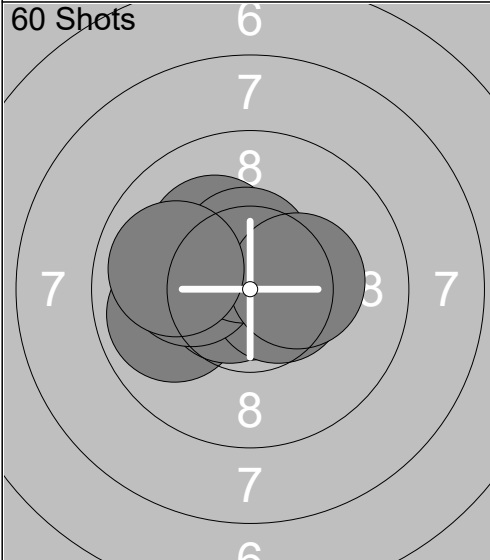
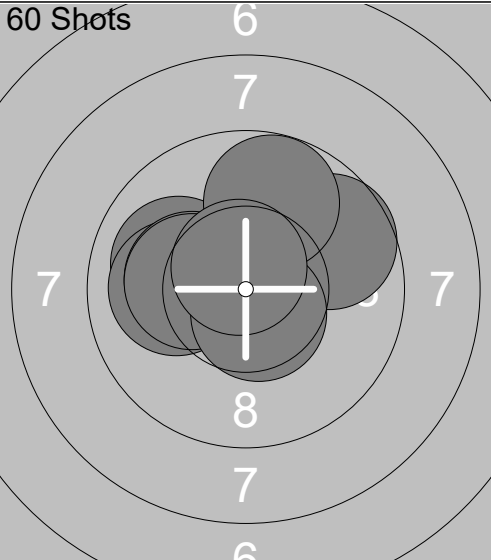
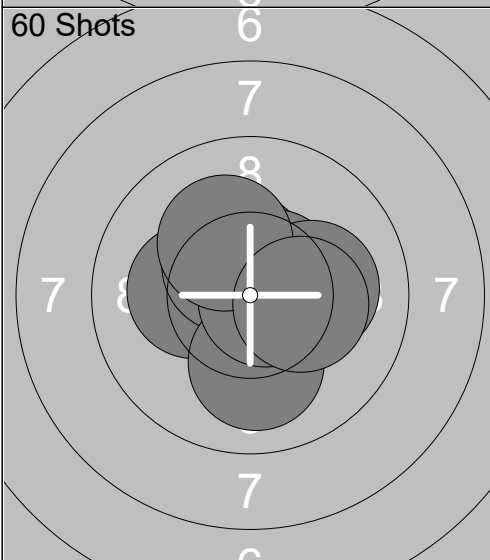
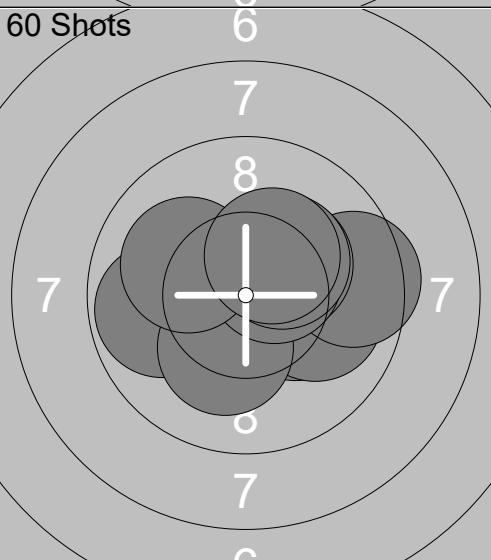
60 Shots 	1: 10.3x ↗ 2: 10.2x ↘ 3: 9.8 ← 4: 9.6 ↖ 5: 10.9x ➤ 6: 10.3x ↗ 7: 9.5 ➔ 8: 10.5x ↗ 9: 10.1 ↑ 10: 10.2x ➤ Series 101.4 101.4	60 Shots 	11: 10.6x ↗ 12: 9.9 ➔ 13: 10.9x ➔ 14: 10.1 ↗ 15: 9.8 ➔ 16: 10.7x ➔ 17: 10.6x ↗ 18: 10.4x ↑ 19: 10.0 ↘ 20: 10.3x ↖ Series 103.3 204.7
60 Shots 	21: 10.3x ↖ 22: 9.9 ← 23: 10.9x ↘ 24: 10.7x ← 25: 10.2x ↗ 26: 10.6x ➤ 27: 10.2x ← 28: 10.5x ↑ 29: 10.3x ➔ 30: 9.9 ← Series 103.5 308.2	60 Shots 	31: 10.0 ← 32: 10.8x ↘ 33: 10.6x ↗ 34: 9.7 ↗ 35: 10.0 ← 36: 10.2x ← 37: 10.2x ← 38: 10.6x ↘ 39: 9.8 ↑ 40: 10.6x ↑ Series 102.5 410.7
60 Shots 	41: 10.9x ↖ 42: 10.5x ↑ 43: 10.6x ↗ 44: 10.2x ← 45: 10.5x ↗ 46: 10.1 ↓ 47: 10.7x ➔ 48: 10.1 ➔ 49: 10.2x ↗ 50: 10.3x ➤ Series 104.1 514.8	60 Shots 	51: 10.3x ➤ 52: 10.0 ➔ 53: 9.8 ← 54: 9.5 ➔ 55: 10.2x ↘ 56: 10.3x ↗ 57: 10.5x ↗ 58: 10.1 ↖ 59: 10.3x ↗ 60: 10.3x ↗ Series 101.3 616.1

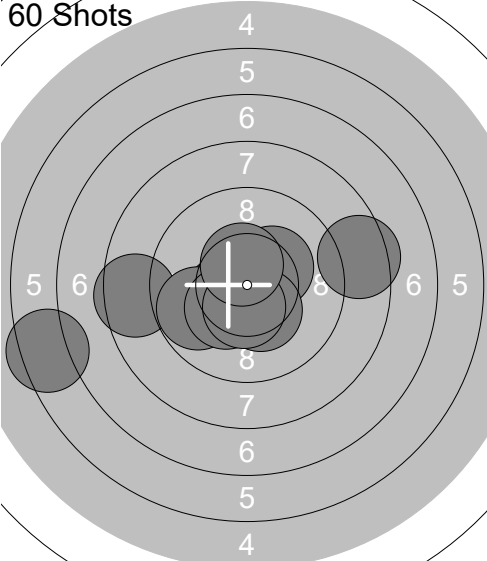
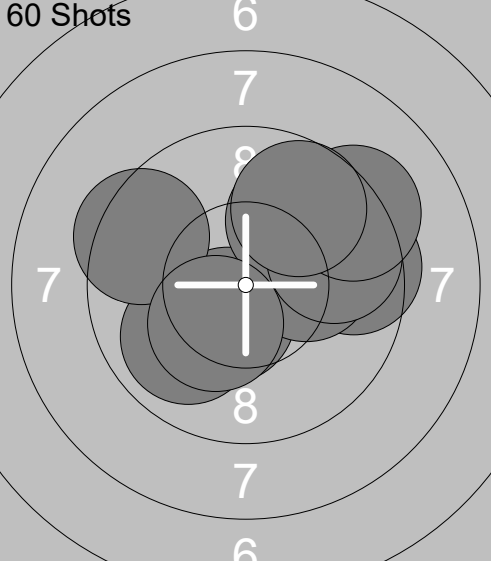
<p>60 Shots</p> 	<p>1: 10.4x ↙ 2: 8.5 ← 3: 9.8 ← 4: 10.3x ↗ 5: 10.3x ↓ 6: 6.4 ← 7: 10.3x ↙ 8: 8.5 → 9: 10.5x ↓ 10: 10.5x ↑</p> <p>Series 95.5</p> <p style="text-align: center;">95.5</p>	<p>60 Shots</p> 	<p>11: 9.5 → 12: 9.9 ↙ 13: 10.5x ↙ 14: 10.1 → 15: 9.9 ↗ 16: 9.7 → 17: 9.4 ↙ 18: 10.3x ↙ 19: 9.2 ↗ 20: 9.7 ↗</p> <p>Series 98.2</p> <p style="text-align: center;">193.7</p>
--	--	--	---

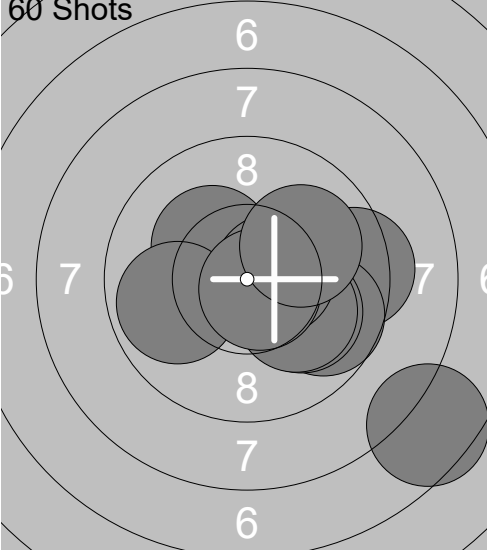
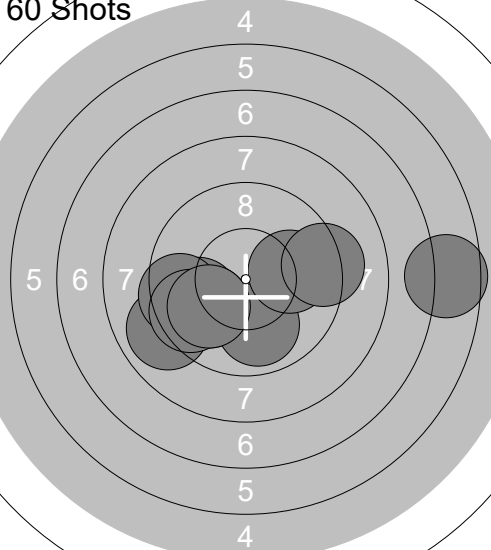
<p>60 Shots</p> 	<p>21: 10.3x ↗ 22: 9.4 → 23: 9.7 → 24: 10.0 ↘ 25: 10.1 ↘ 26: 7.5 ↘ 27: 10.5x → 28: 9.9 ← 29: 10.7x ↘ 30: 10.0 ↗</p> <p>Series 98.1</p> <p style="text-align: center;">291.8</p>	<p>60 Shots</p> 	<p>31: 8.9 ↙ 32: 10.0 ↙ 33: 9.9 ↓ 34: 9.8 ← 35: 9.5 ← 36: 10.0 → 37: 9.6 ← 38: 9.2 → 39: 6.6 → 40: 9.9 ↙</p> <p>Series 93.4</p> <p style="text-align: center;">385.2</p>
---	---	---	--

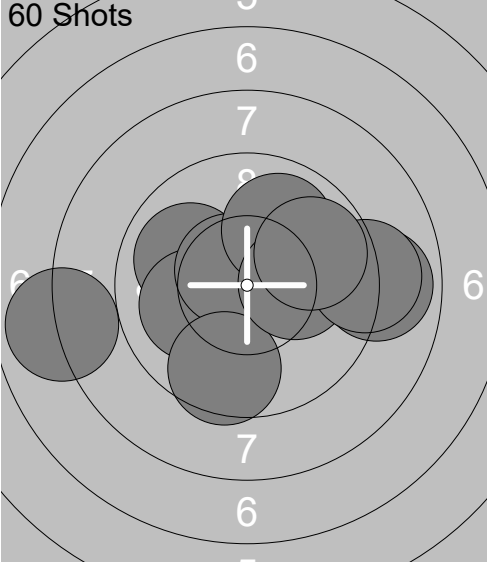
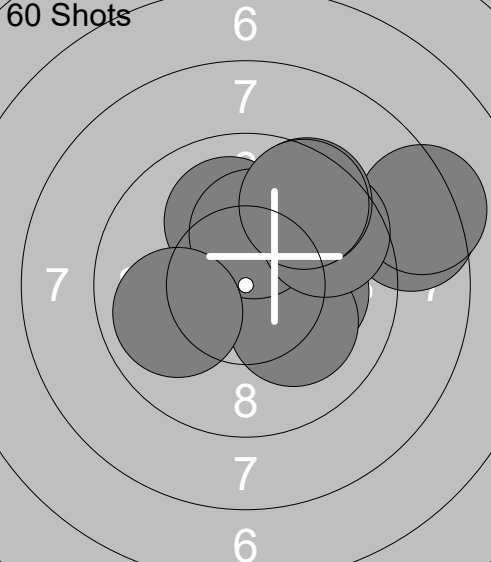
<p>60 Shots</p> 	<p>41: 10.0 ↙ 42: 10.1 ← 43: 10.6x ↙ 44: 9.9 ↗ 45: 8.9 → 46: 9.6 ↓ 47: 10.2x → 48: 9.1 → 49: 9.8 ↗ 50: 7.9 ←</p> <p>Series 96.1</p> <p style="text-align: center;">481.3</p>	<p>60 Shots</p> 	<p>51: 10.1 → 52: 10.1 ↘ 53: 8.5 → 54: 10.0 ↑ 55: 8.3 → 56: 10.2x ↑ 57: 9.9 ← 58: 9.6 ↗ 59: 9.5 ↗ 60: 9.6 ↗</p> <p>Series 95.8</p> <p style="text-align: center;">577.1</p>
--	--	--	---

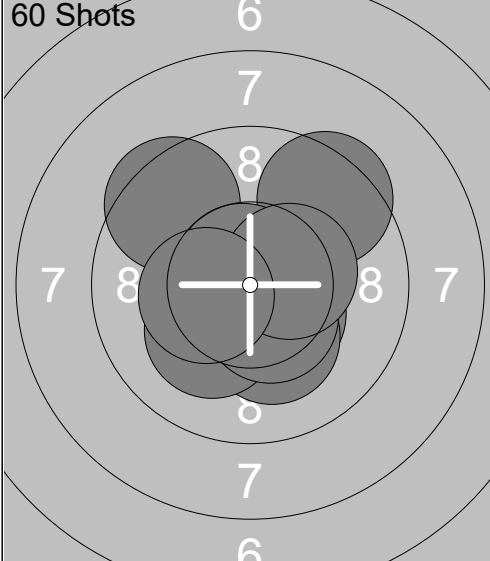
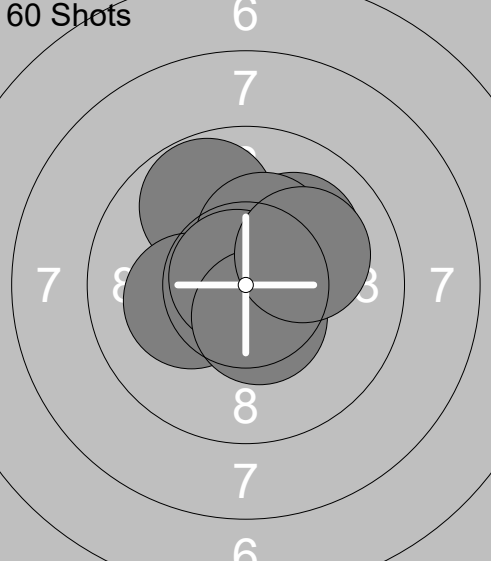
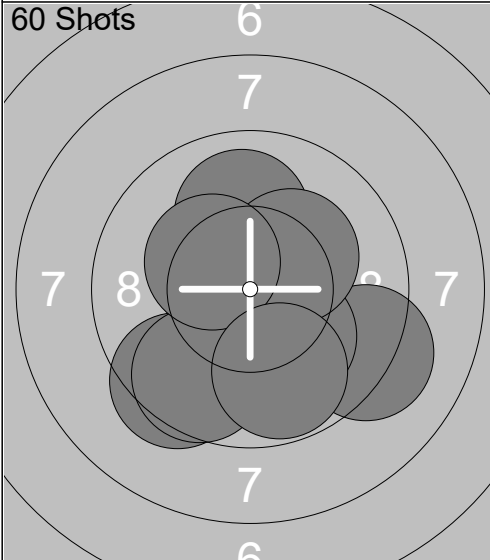
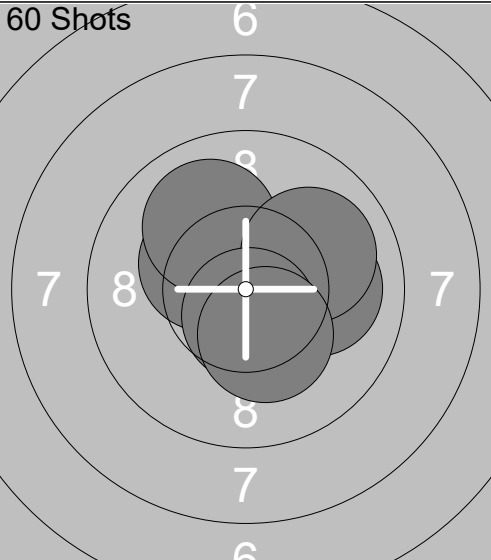
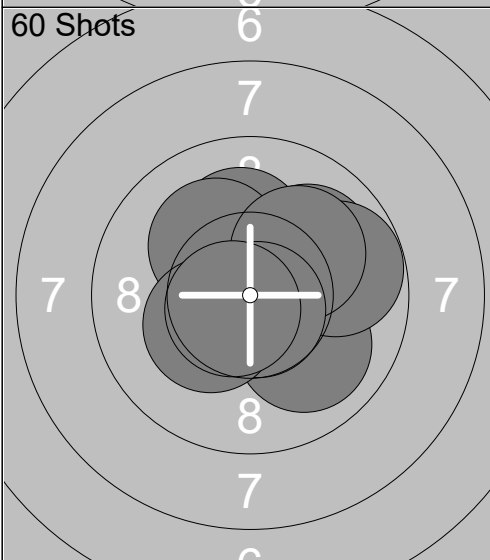
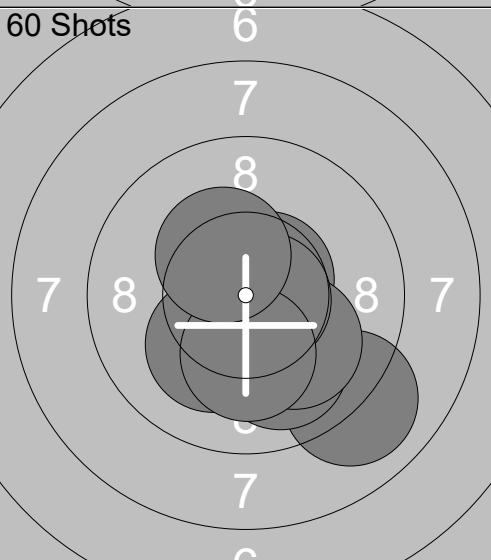
<p>60 Shots</p> 	<p>1: 9.5 ↗ 2: 10.4x ↘ 3: 10.9x ↘ 4: 10.2x ↘ 5: 9.4 ↗ 6: 10.7x ↗ 7: 10.2x ↘ 8: 10.5x ↘ 9: 10.4x → 10: 10.3x ←</p> <p>Series 102.5 102.5</p>	<p>60 Shots</p> 	<p>11: 10.5x ↗ 12: 10.1 ↗ 13: 10.4x ← 14: 10.6x ↑ 15: 9.8 ↗ 16: 10.3x ↑ 17: 10.2x ← 18: 10.8x ↖ 19: 10.5x ↘ 20: 10.1 ↗</p> <p>Series 103.3 205.8</p>
<p>60 Shots</p> 	<p>21: 10.5x ↘ 22: 9.2 → 23: 10.5x ↗ 24: 10.0 ↑ 25: 9.4 ↘ 26: 10.1 ↘ 27: 9.6 ↘ 28: 10.3x ↗ 29: 10.3x ↖ 30: 9.8 ↘</p> <p>Series 99.7 305.5</p>	<p>60 Shots</p> 	<p>31: 10.4x → 32: 10.0 → 33: 10.5x ↖ 34: 10.3x ↖ 35: 10.4x ↗ 36: 10.7x ↑ 37: 10.0 ↖ 38: 10.0 ↗ 39: 10.6x ↘ 40: 10.3x ↘</p> <p>Series 103.2 408.7</p>
<p>60 Shots</p> 	<p>41: 10.6x ↘ 42: 10.0 ↗ 43: 10.0 ↘ 44: 10.1 ↑ 45: 9.8 → 46: 10.2x ↗ 47: 10.1 ↗ 48: 10.7x ↘ 49: 10.3x ↖ 50: 10.7x ↖</p> <p>Series 102.5 511.2</p>	<p>60 Shots</p> 	<p>51: 10.6x ↗ 52: 9.0 ↘ 53: 10.5x ↘ 54: 10.5x ↘ 55: 10.0 ↘ 56: 10.1 ↘ 57: 10.2x ↖ 58: 10.7x → 59: 10.2x ↘ 60: 10.3x ↖</p> <p>Series 102.1 613.3</p>

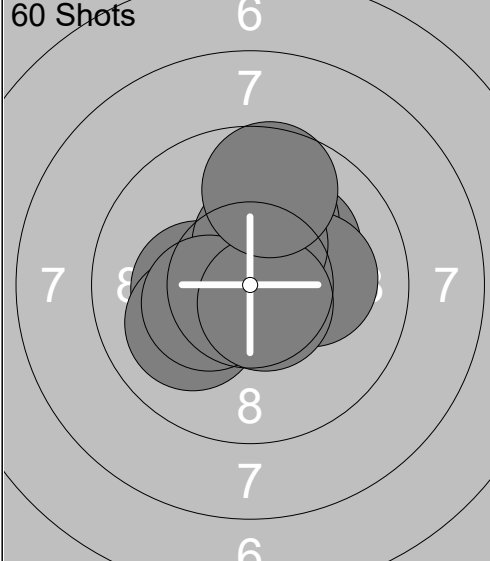
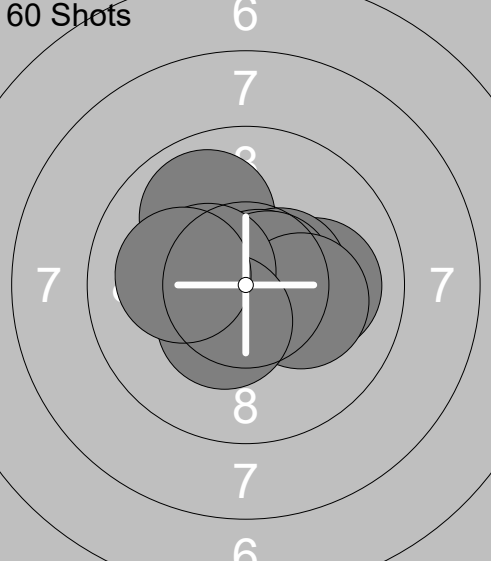
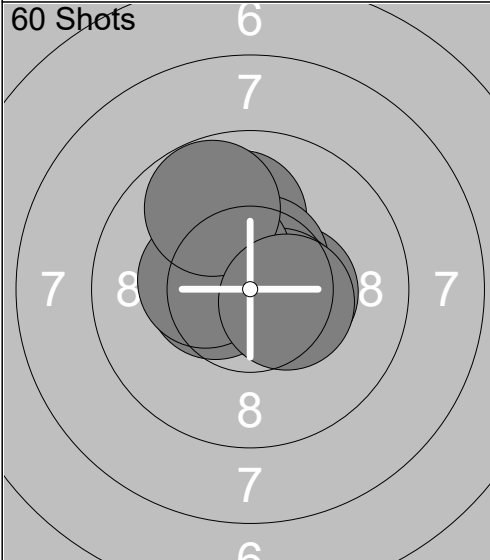
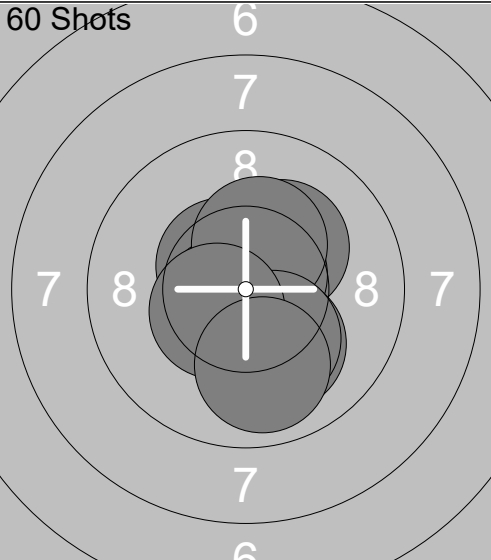
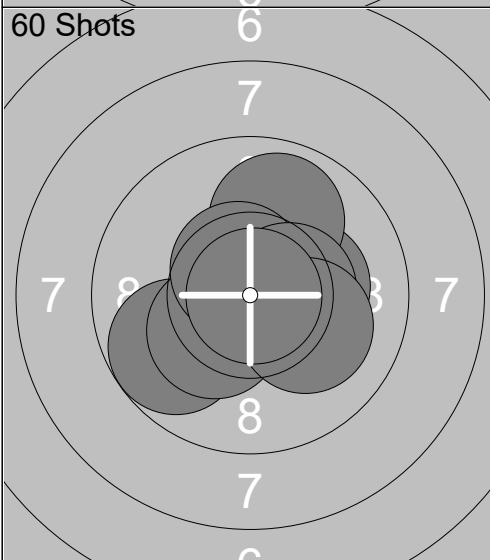
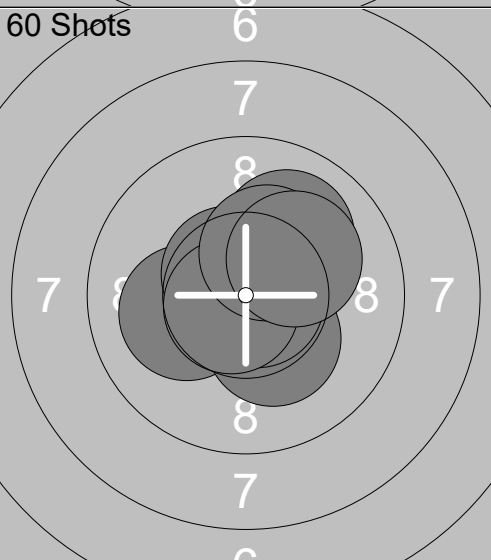
<p>60 Shots</p> 	<p>1: 10.3x ←</p> <p>2: 10.2x ↗</p> <p>3: 10.3x →</p> <p>4: 10.1 ↑</p> <p>5: 10.1 →</p> <p>6: 10.0 ←</p> <p>7: 10.4x ↑</p> <p>8: 10.4x ←</p> <p>9: 10.6x ↘</p> <p>10: 9.7 ↑</p> <p>Series 102.1</p> <p>102.1</p>	<p>60 Shots</p> 	<p>11: 10.1 →</p> <p>12: 9.9 ↖</p> <p>13: 10.5x ↙</p> <p>14: 10.5x →</p> <p>15: 10.8x ↗</p> <p>16: 10.7x →</p> <p>17: 10.2x →</p> <p>18: 10.4x ←</p> <p>19: 10.4x ↙</p> <p>20: 10.1 ←</p> <p>Series 103.6</p> <p>205.7</p>
<p>60 Shots</p> 	<p>21: 10.4x ↖</p> <p>22: 10.4x →</p> <p>23: 10.0 ↑</p> <p>24: 10.6x ↑</p> <p>25: 10.6x →</p> <p>26: 10.4x ↖</p> <p>27: 10.5x ←</p> <p>28: 10.3x ←</p> <p>29: 9.8 ↑</p> <p>30: 10.4x →</p> <p>Series 103.4</p> <p>309.1</p>	<p>60 Shots</p> 	<p>31: 10.5x ↖</p> <p>32: 10.2x ↗</p> <p>33: 10.5x ↙</p> <p>34: 10.7x ↙</p> <p>35: 10.7x ↗</p> <p>36: 10.1 ↘</p> <p>37: 10.3x ↑</p> <p>38: 10.2x ↘</p> <p>39: 10.5x ↙</p> <p>40: 9.9 ↘</p> <p>Series 103.6</p> <p>412.7</p>
<p>60 Shots</p> 	<p>41: 9.8 ←</p> <p>42: 10.6x ↗</p> <p>43: 10.3x →</p> <p>44: 10.3x ↙</p> <p>45: 10.6x ↑</p> <p>46: 9.9 ↑</p> <p>47: 10.6x ↗</p> <p>48: 10.4x →</p> <p>49: 10.1 ↘</p> <p>50: 10.9x →</p> <p>Series 103.5</p> <p>516.2</p>	<p>60 Shots</p> 	<p>51: 10.1 ←</p> <p>52: 10.8x ↖</p> <p>53: 10.6x →</p> <p>54: 10.3x ↘</p> <p>55: 10.6x ↖</p> <p>56: 10.8x →</p> <p>57: 10.7x ↙</p> <p>58: 10.0 ↗</p> <p>59: 10.3x ↑</p> <p>60: 10.2x ↗</p> <p>Series 104.4</p> <p>620.6</p>

<p>60 Shots</p>	<p>1: 10.2x ↓ 2: 10.3x ↗ 3: 10.5x ↗ 4: 10.5x ↗ 5: 9.7 ↑ 6: 10.2x ↙ 7: 10.0 → 8: 9.5 ↗ 9: 10.6x ➤ 10: 10.2x ↘</p> <p>Series 101.7 101.7</p>	<p>60 Shots</p>	<p>11: 9.4 ↗ 12: 9.7 ↖ 13: 10.5x ➤ 14: 9.9 ↑ 15: 10.7x ↙ 16: 9.8 ↑ 17: 9.7 ➤ 18: 9.7 ↗ 19: 10.5x ↙ 20: 9.8 ↗</p> <p>Series 99.7 201.4</p>
<p>60 Shots</p>	<p>21: 10.4x ↙ 22: 10.6x ← 23: 10.7x ↑ 24: 9.7 ↙ 25: 10.2x ↑ 26: 10.2x ↗ 27: 8.9 ← 28: 9.5 ↗ 29: 10.2x ← 30: 9.6 →</p> <p>Series 100.0 301.4</p>	<p>60 Shots</p>	<p>31: 10.7x ➤ 32: 10.1 ↑ 33: 10.4x ↑ 34: 10.1 → 35: 10.2x ➤ 36: 10.1 ↗ 37: 9.8 ➤ 38: 10.9x ← 39: 9.5 ↑ 40: 10.6x ↗</p> <p>Series 102.4 403.8</p>
<p>60 Shots</p>	<p>41: 10.5x ➤ 42: 10.5x ↘ 43: 10.6x ↘ 44: 10.8x ↘ 45: 10.2x ➤ 46: 10.4x ➤ 47: 8.9 → 48: 10.4x ↙ 49: 10.2x ↘ 50: 10.2x ↗</p> <p>Series 102.7 506.5</p>	<p>60 Shots</p>	<p>51: 10.5x ➤ 52: 10.4x ↘ 53: 10.4x ↙ 54: 10.5x ↙ 55: 10.3x ↙ 56: 9.8 ➤ 57: 10.4x ↗ 58: 10.4x ← 59: 9.7 ↓ 60: 10.1 ➤</p> <p>Series 102.5 609.0</p>

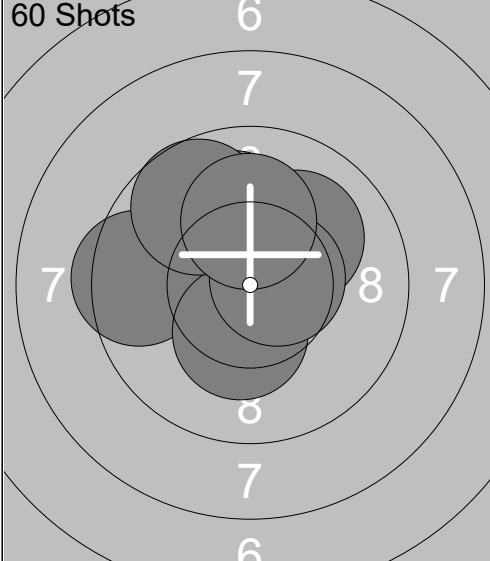
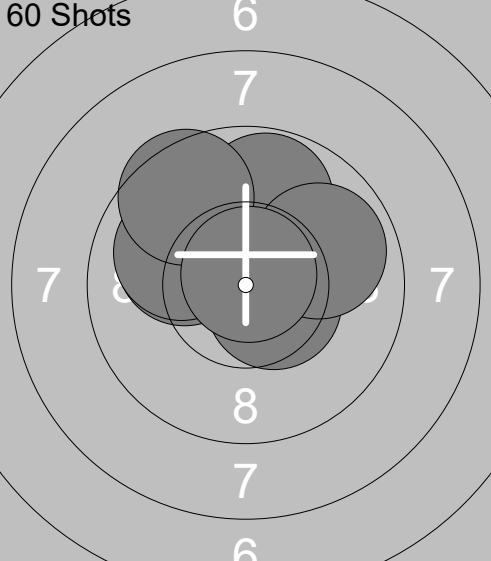
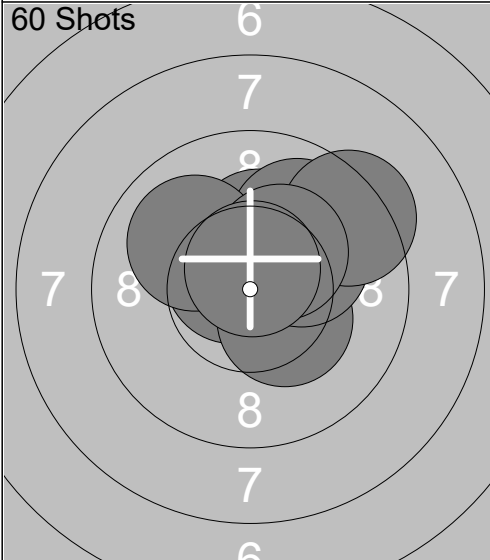
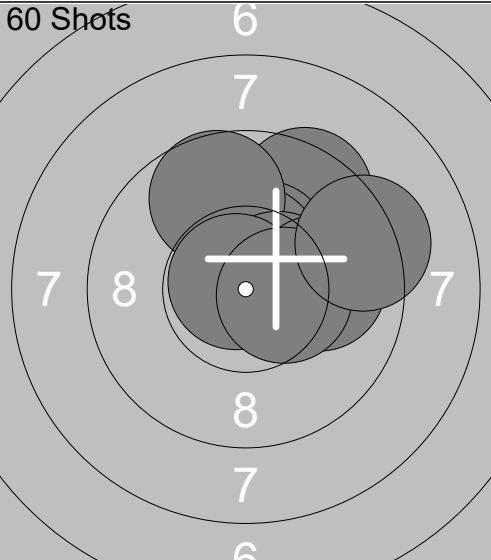
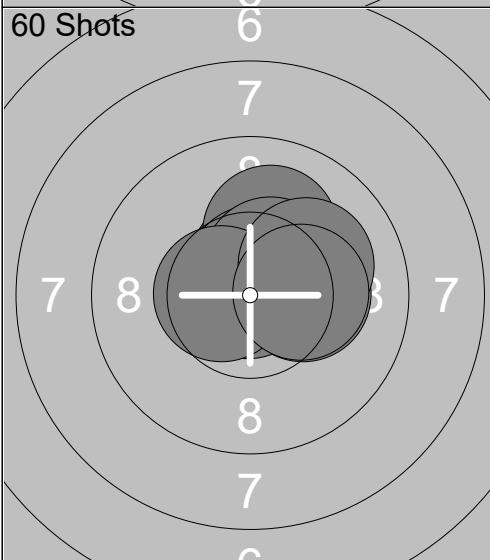
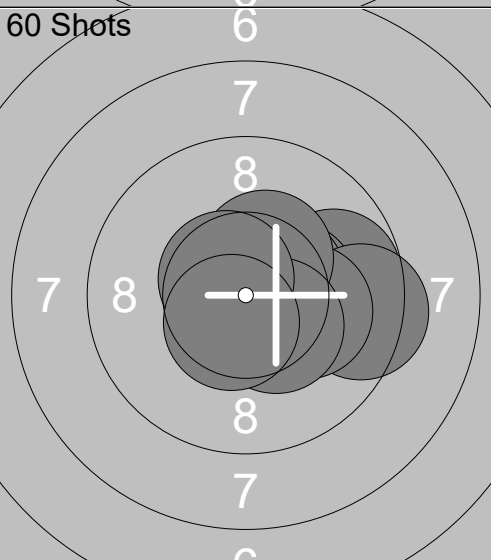
<p>60 Shots</p>  <p>60 Shots</p> 	<p>1: 10.1 ↑</p> <p>2: 10.7x →</p> <p>3: 10.0 ↑</p> <p>4: 10.3x ↑</p> <p>5: 9.5 ←</p> <p>6: 10.3x ↓</p> <p>7: 9.7 ↖</p> <p>8: 10.1 ↗</p> <p>9: 10.6x →</p> <p>10: 10.1 ↑</p> <hr/> <p>Series 101.4</p> <p>101.4</p>	<p>11: 10.6x →</p> <p>12: 9.6 ↖</p> <p>13: 10.1 ↖</p> <p>14: 10.5x →</p> <p>15: 9.8 ↑</p> <p>16: 10.0 ↖</p> <p>17: 9.5 ↖</p> <p>18: 10.5x →</p> <p>19: 9.9 →</p> <p>20: 10.8x ↑</p> <hr/> <p>Series 101.3</p> <p>202.7</p>
<p>60 Shots</p>  <p>60 Shots</p> 	<p>21: 10.4x ↑</p> <p>22: 10.7x ↖</p> <p>23: 10.2x ↑</p> <p>24: 10.3x ↘</p> <p>25: 9.9 ↗</p> <p>26: 10.2x ↗</p> <p>27: 9.3 ↗</p> <p>28: 10.0 ↖</p> <p>29: 10.3x ↗</p> <p>30: 10.7x ↑</p> <hr/> <p>Series 102.0</p> <p>304.7</p>	<p>31: 9.5 ↗</p> <p>32: 10.4x ↑</p> <p>33: 10.4x ↑</p> <p>34: 10.5x ↑</p> <p>35: 9.7 ↑</p> <p>36: 10.5x →</p> <p>37: 10.8x ↖</p> <p>38: 10.0 →</p> <p>39: 10.4x →</p> <p>40: 9.3 →</p> <hr/> <p>Series 101.5</p> <p>406.2</p>
<p>60 Shots</p>  <p>60 Shots</p> 	<p>41: 10.2x →</p> <p>42: 10.5x ↑</p> <p>43: 10.1 ↑</p> <p>44: 10.9x ↖</p> <p>45: 10.7x ↑</p> <p>46: 10.4x →</p> <p>47: 10.5x ↗</p> <p>48: 10.6x ←</p> <p>49: 10.1 ↗</p> <p>50: 10.3x →</p> <hr/> <p>Series 104.3</p> <p>510.5</p>	<p>51: 9.8 →</p> <p>52: 10.4x →</p> <p>53: 10.5x →</p> <p>54: 9.4 →</p> <p>55: 10.7x ↗</p> <p>56: 10.1 →</p> <p>57: 10.4x ↑</p> <p>58: 10.4x ↘</p> <p>59: 10.6x ↖</p> <p>60: 10.5x ↓</p> <hr/> <p>Series 102.8</p> <p>613.3</p>

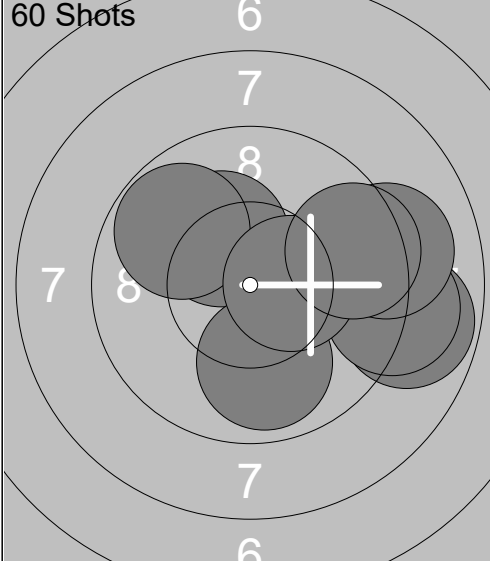
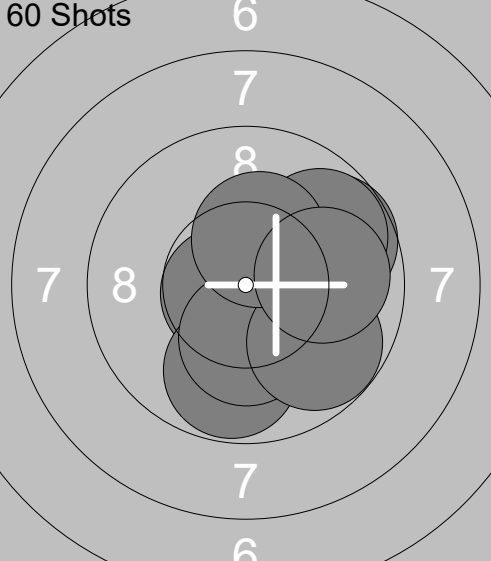
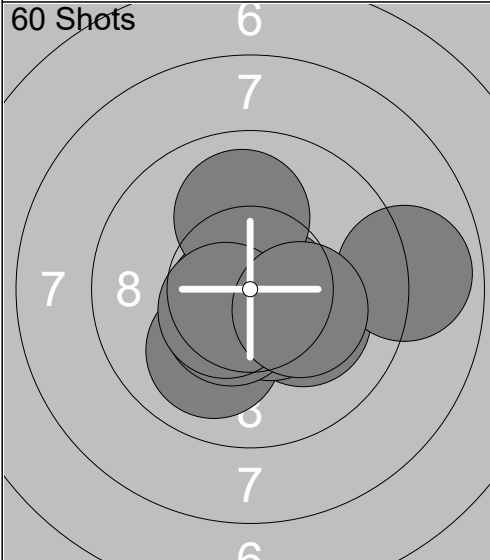
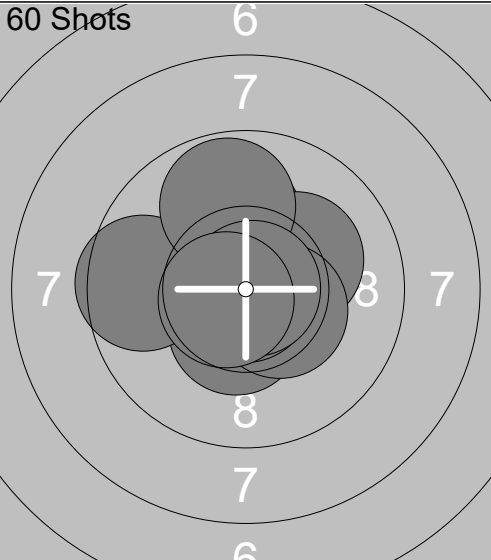
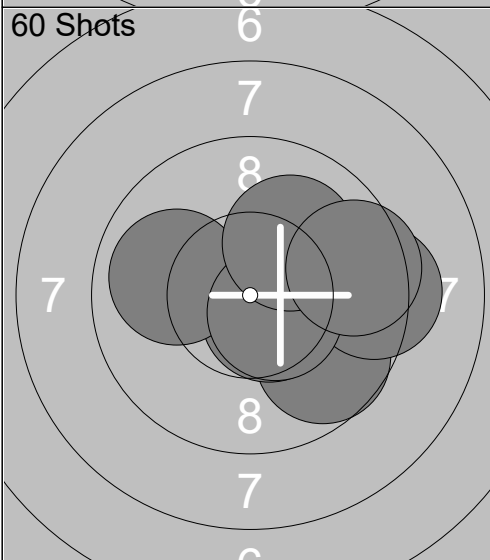
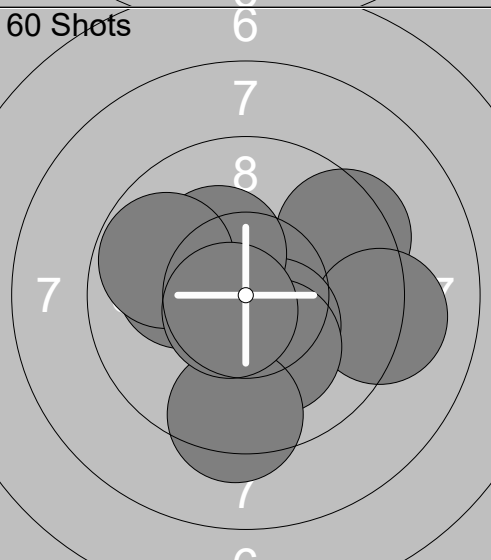
<p>60 Shots</p> 	<p>1: 10.2x ↗ 2: 8.8 → 3: 9.9 ↓ 4: 9.3 → 5: 9.5 → 6: 9.0 → 7: 9.1 → 8: 9.8 ↗ 9: 10.4x → 10: 9.5 →</p> <p>Series 95.5 95.5</p>	<p>60 Shots</p> 	<p>11: 10.3x ↗ 12: 10.2x → 13: 9.7 ↗ 14: 10.7x ← 15: 9.8 ↓ 16: 10.2x ↓ 17: 9.8 ↘ 18: 9.8 ↗ 19: 10.3x ↑ 20: 9.9 →</p> <p>Series 100.7 196.2</p>
<p>60 Shots</p> 	<p>21: 10.0 ↓ 22: 10.7x ← 23: 10.1 → 24: 10.5x ↓ 25: 10.7x → 26: 8.9 → 27: 10.5x ↓ 28: 10.0 ↑ 29: 10.5x ← 30: 10.2x →</p> <p>Series 102.1 298.3</p>	<p>60 Shots</p> 	<p>31: 10.3x ↗ 32: 10.4x ↓ 33: 10.0 ↑ 34: 10.2x ↗ 35: 9.6 ← 36: 10.4x ↘ 37: 10.9x ↓ 38: 9.8 ↑ 39: 10.9x → 40: 10.7x ←</p> <p>Series 103.2 401.5</p>
<p>60 Shots</p> 	<p>41: 9.7 ↓ 42: 10.6x ↓ 43: 10.4x ↗ 44: 10.3x ↗ 45: 10.0 → 46: 10.0 ← 47: 9.3 → 48: 10.5x ↓ 49: 10.1 ↗ 50: 9.5 →</p> <p>Series 100.4 501.9</p>	<p>60 Shots</p> 	<p>51: 10.1 ← 52: 9.4 ↗ 53: 10.8x ← 54: 9.2 → 55: 10.4x ↓ 56: 10.2x ↓ 57: 10.3x ↗ 58: 9.8 ← 59: 9.4 ↓ 60: 10.7x ←</p> <p>Series 100.3 602.2</p>

Relay 2	Lane 20	Karlie Lynn
-------------------	-------------------	--------------------

WVU Mobile Range			
------------------	--	--	--

18.11.2023	Walther Cup 2023	West Virginia University
------------	------------------	--------------------------

Comment	Signature
---------	-----------

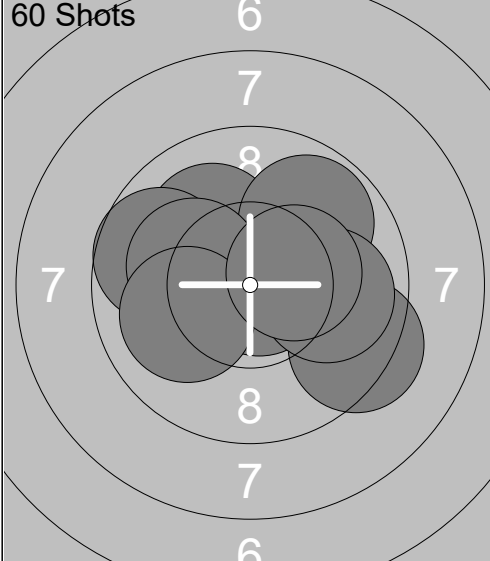
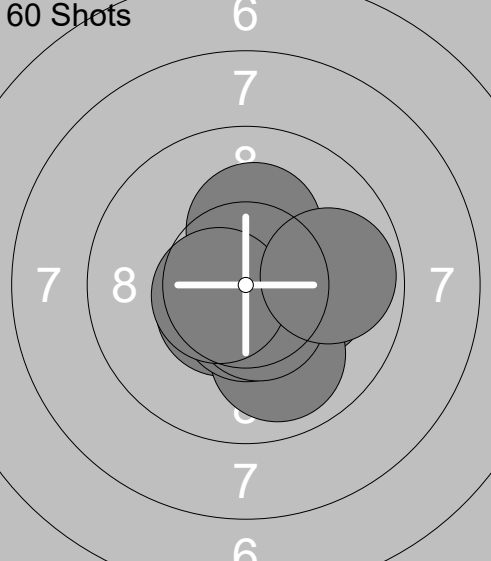
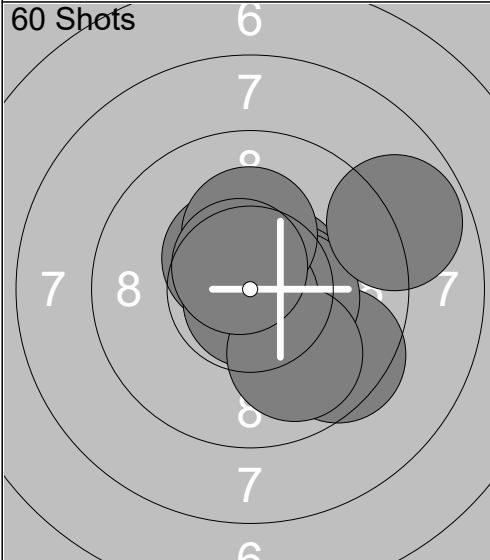
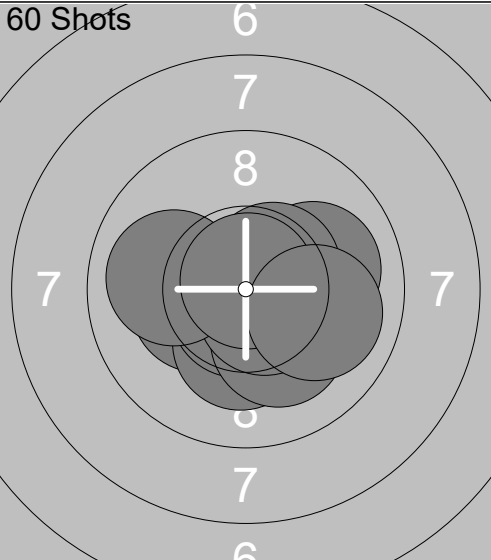
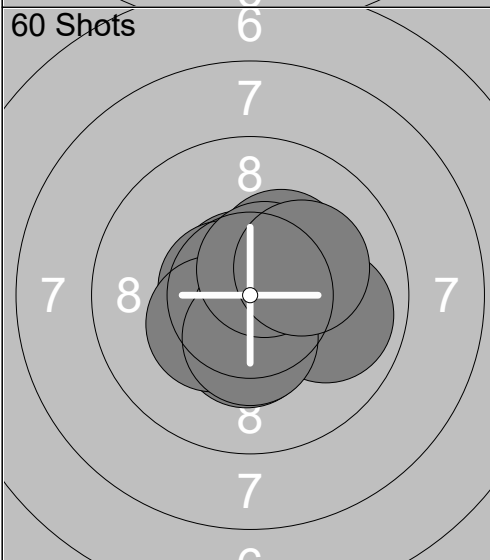
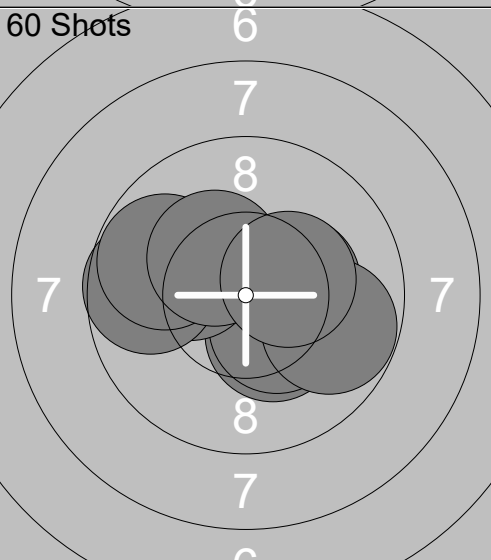
<p>60 Shots</p> 	<p>1: 10.1 ↗ 2: 10.2x ← 3: 9.3 ↘ 4: 9.8 ↗ 5: 9.7 ← 6: 10.8x ↘ 7: 10.2x ← 8: 9.9 → 9: 10.0 ← 10: 10.3x →</p> <p>Series 100.3 100.3</p>	<p>60 Shots</p> 	<p>11: 10.5x ↘ 12: 10.2x → 13: 10.6x ↗ 14: 9.9 ↘ 15: 10.6x ↓ 16: 10.5x ↗ 17: 10.5x ↘ 18: 10.2x ↑ 19: 10.6x ← 20: 9.9 →</p> <p>Series 103.5 203.8</p>
<p>60 Shots</p> 	<p>21: 10.5x ↗ 22: 10.5x ↗ 23: 9.5 ↘ 24: 10.4x → 25: 10.4x → 26: 8.8 → 27: 10.8x ↓ 28: 10.2x ↑ 29: 9.9 ↘ 30: 10.6x ↗</p> <p>Series 101.6 305.4</p>	<p>60 Shots</p> 	<p>31: 10.0 → 32: 10.3x ← 33: 10.2x ↓ 34: 10.5x ↗ 35: 10.7x ↓ 36: 10.2x ↘ 37: 10.6x ↘ 38: 10.0 ← 39: 10.8x ↑ 40: 10.0 →</p> <p>Series 103.3 408.7</p>
<p>60 Shots</p> 	<p>41: 10.7x ↗ 42: 10.6x ← 43: 10.3x ↗ 44: 10.4x ↓ 45: 10.3x ← 46: 10.6x ↓ 47: 9.9 → 48: 10.4x ↓ 49: 10.6x ↗ 50: 10.2x ↗</p> <p>Series 104.0 512.7</p>	<p>60 Shots</p> 	<p>51: 10.3x → 52: 10.3x ↘ 53: 10.3x → 54: 10.4x ↘ 55: 9.8 → 56: 10.1 ← 57: 9.7 ← 58: 9.8 ← 59: 10.3x ↗ 60: 10.4x →</p> <p>Series 101.4 614.1</p>

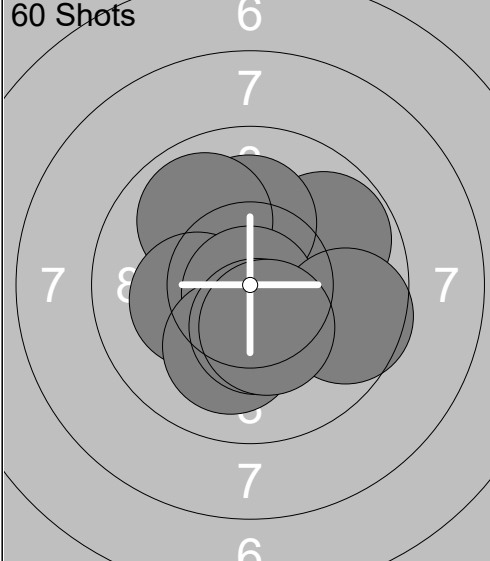
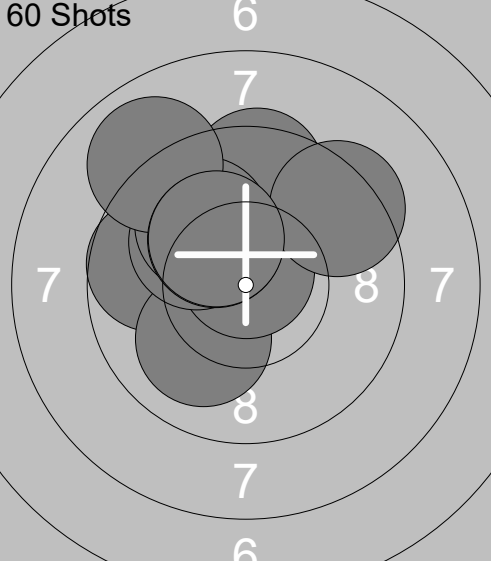
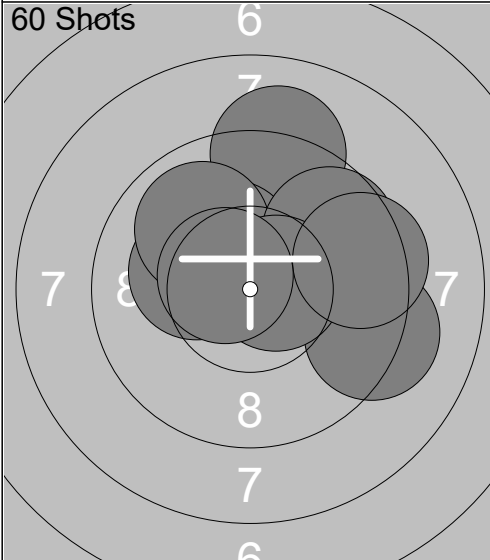
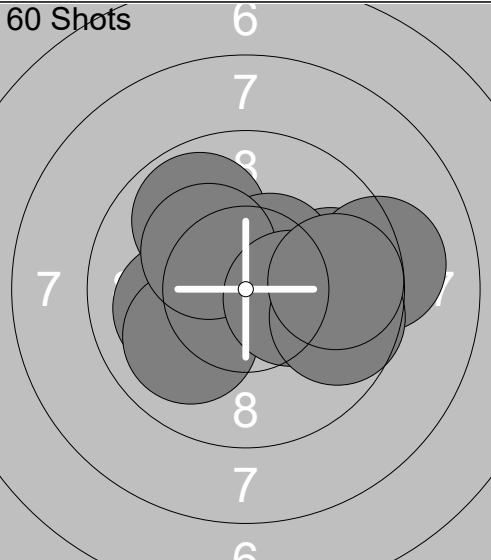
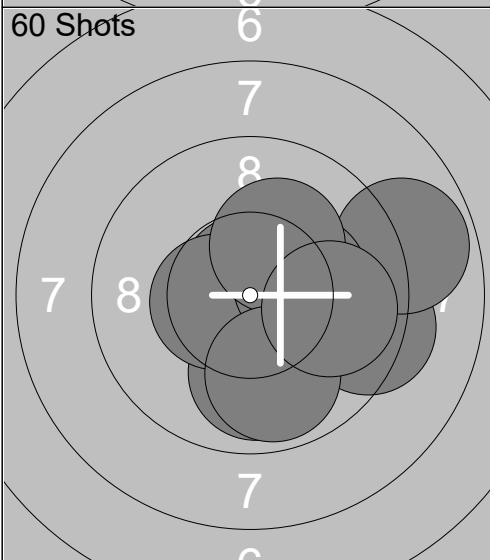
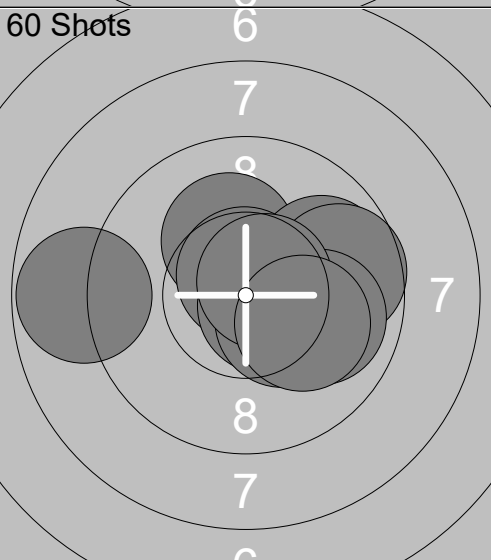
<p>60 Shots</p>  <p style="text-align: center;">6 7 7 7</p>	<p>1: 10.0 ↖ 2: 9.8 ↗ 3: 10.1 ↑ 4: 9.9 ↖ 5: 10.2x ← 6: 10.8x ↓ 7: 10.1 ↓ 8: 10.4x ↓ 9: 9.6 → 10: 10.3x ↓</p> <p>Series 101.2 101.2</p>	<p>60 Shots</p>  <p style="text-align: center;">6 7 7 7</p>	<p>11: 9.7 ← 12: 10.0 ↙ 13: 9.5 ↑ 14: 10.8x ↑ 15: 10.1 ↖ 16: 10.0 ↖ 17: 9.0 ↖ 18: 9.4 ↗ 19: 10.2x ↖ 20: 10.2x ↖</p> <p>Series 98.9 200.1</p>
<p>60 Shots</p>  <p style="text-align: center;">6 6 7 7 7</p>	<p>21: 10.2x ← 22: 10.1 ↗ 23: 9.1 ↑ 24: 10.3x ↖ 25: 9.9 ↖ 26: 9.7 ↗ 27: 9.2 → 28: 10.6x → 29: 9.4 → 30: 10.6x ←</p> <p>Series 99.1 299.2</p>	<p>60 Shots</p>  <p style="text-align: center;">6 6 7 7 7</p>	<p>31: 9.8 → 32: 9.9 ↖ 33: 10.5x ↗ 34: 10.0 ← 35: 10.0 ↙ 36: 9.2 → 37: 10.2x ↖ 38: 10.3x → 39: 9.7 → 40: 9.8 →</p> <p>Series 99.4 398.6</p>
<p>60 Shots</p>  <p style="text-align: center;">6 6 7 7 7</p>	<p>41: 9.3 → 42: 10.8x ↑ 43: 9.9 ↓ 44: 10.5x ← 45: 8.8 → 46: 10.3x → 47: 10.0 → 48: 10.2x ↖ 49: 9.9 ↓ 50: 9.9 →</p> <p>Series 99.6 498.2</p>	<p>60 Shots</p>  <p style="text-align: center;">6 6 7 7 7</p>	<p>51: 10.2x ↑ 52: 9.9 → 53: 10.7x ↑ 54: 10.7x → 55: 9.7 → 56: 9.9 → 57: 10.4x → 58: 10.6x ↗ 59: 8.8 ← 60: 10.1 →</p> <p>Series 101.0 599.2</p>

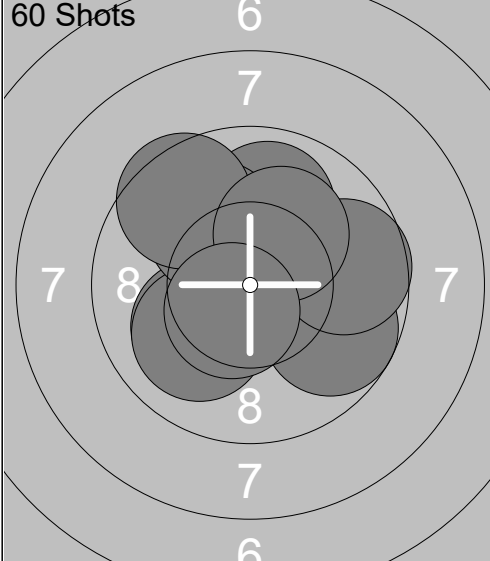
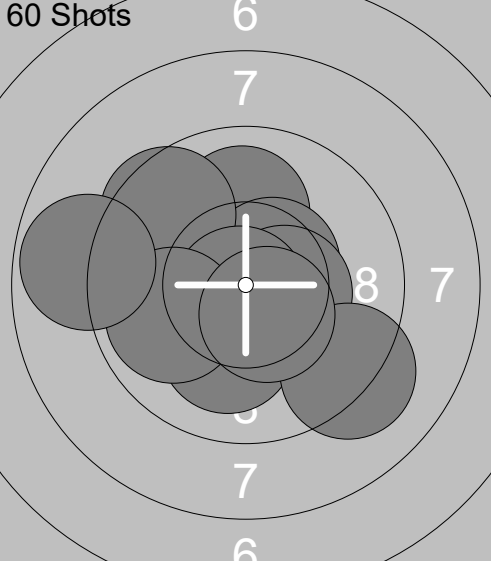
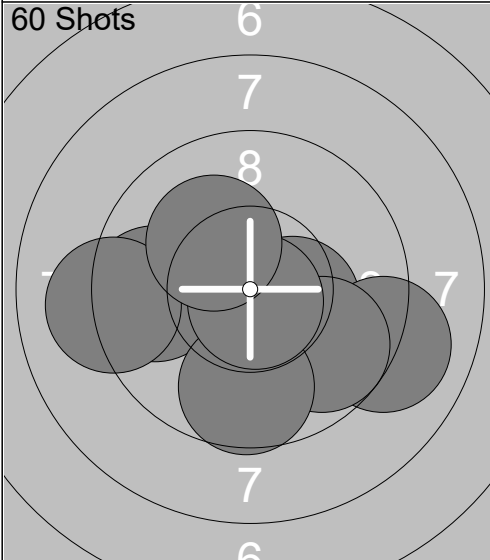
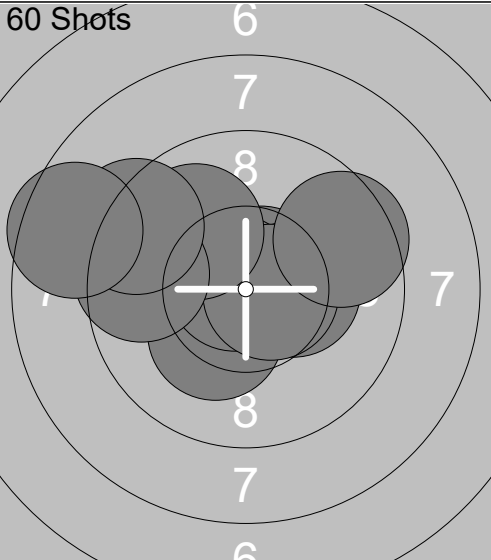
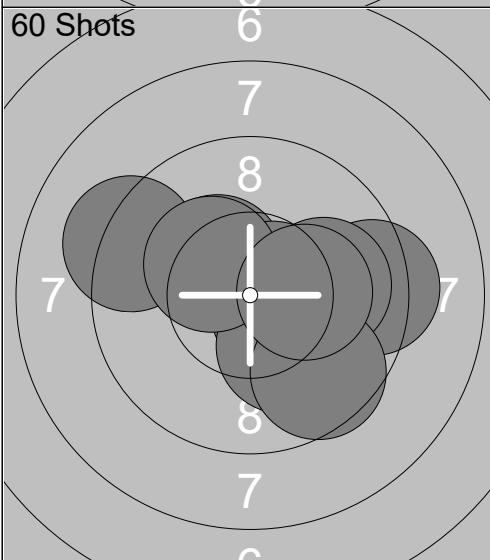
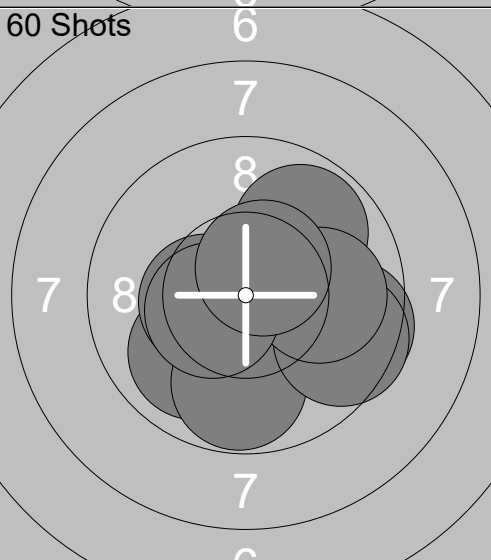
<p>60 Shots</p> 	<p>1: 10.3x ↗ 2: 10.1 ↙ 3: 9.7 → 4: 10.0 ↙ 5: 9.7 → 6: 9.9 ↗ 7: 10.1 ↗ 8: 9.5 ↗ 9: 10.2x ↗ 10: 10.5x ↙</p> <p>Series 100.0 100.0</p>	<p>60 Shots</p> 	<p>11: 10.0 ↗ 12: 10.5x ↗ 13: 9.6 ↙ 14: 10.4x → 15: 10.1 ↘ 16: 10.8x ↙ 17: 9.2 ↘ 18: 9.9 ← 19: 8.8 ← 20: 10.5x ↘</p> <p>Series 99.8 199.8</p>
<p>60 Shots</p> 	<p>21: 10.6x ↘ 22: 10.4x ↘ 23: 10.4x → 24: 9.7 ← 25: 9.0 → 26: 9.7 ↘ 27: 9.1 ← 28: 9.7 ↘ 29: 10.8x ↘ 30: 10.2x ↗</p> <p>Series 99.6 299.4</p>	<p>60 Shots</p> 	<p>31: 10.3x ↘ 32: 10.7x ↗ 33: 10.8x ↙ 34: 10.3x → 35: 10.6x → 36: 9.9 ↗ 37: 9.5 ↗ 38: 9.6 ← 39: 9.3 ↙ 40: 8.6 ←</p> <p>Series 99.6 399.0</p>
<p>60 Shots</p> 	<p>41: 10.3x ↗ 42: 10.5x ↘ 43: 9.3 → 44: 10.6x → 45: 10.1 ↘ 46: 9.2 ↙ 47: 10.0 → 48: 10.3x ↗ 49: 9.6 ↘ 50: 10.2x →</p> <p>Series 100.1 499.1</p>	<p>60 Shots</p> 	<p>51: 9.6 → 52: 10.0 ↘ 53: 9.8 ↘ 54: 10.4x ↗ 55: 9.6 → 56: 9.9 ↗ 57: 10.4x ← 58: 10.0 → 59: 10.5x ← 60: 10.5x ↗</p> <p>Series 100.7 599.8</p>

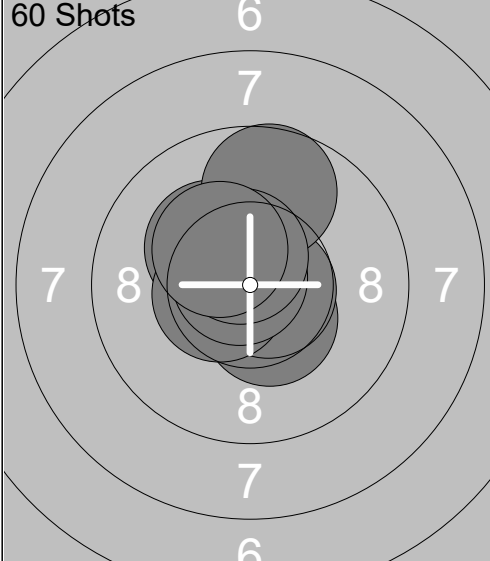
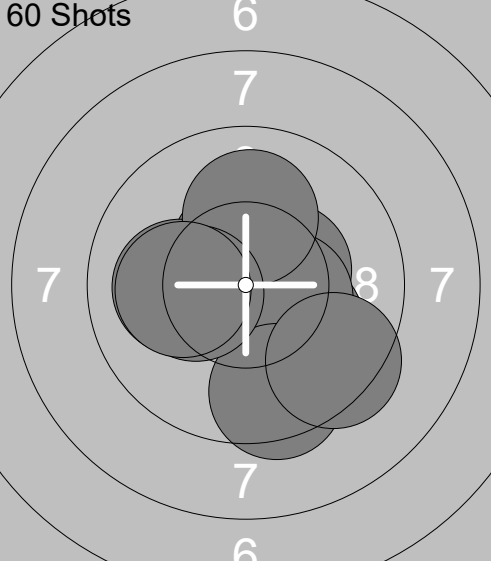
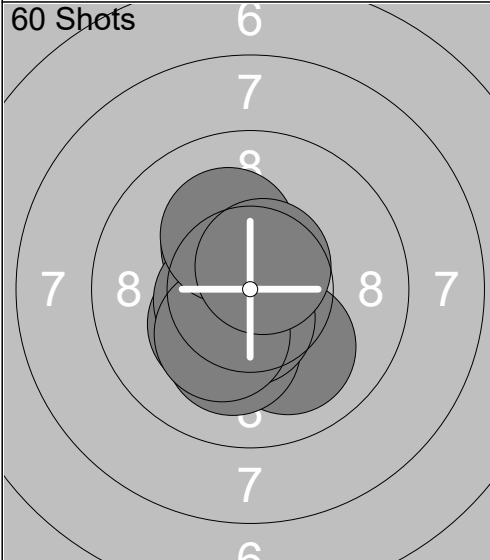
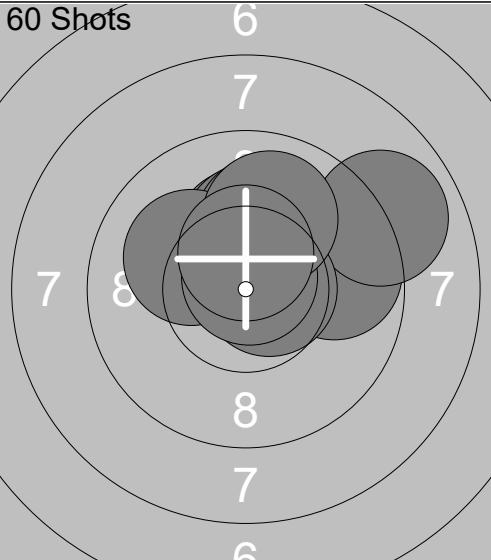
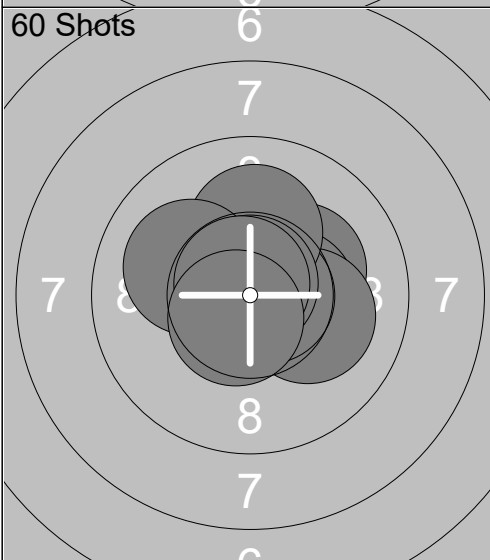
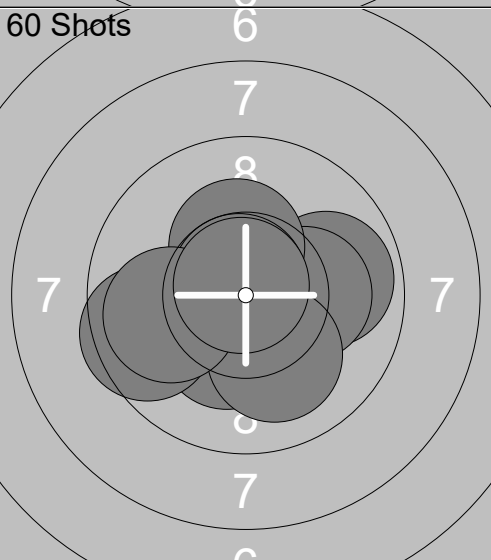
<p>60 Shots</p> 	<p>1: 10.7x ↙ 2: 10.4x ↘ 3: 10.7x → 4: 10.3x ↗ 5: 10.4x ↗ 6: 10.5x ↙ 7: 10.8x ↙ 8: 9.7 ↑ 9: 10.6x ↗ 10: 10.3x ↗</p> <p>Series 104.4 104.4</p>	<p>60 Shots</p> 	<p>11: 10.5x ↑ 12: 10.4x → 13: 10.1 ↘ 14: 10.4x → 15: 9.5 ↘ 16: 9.4 ↘ 17: 10.1 ← 18: 10.1 ↑ 19: 10.3x ← 20: 10.1 ←</p> <p>Series 100.9 205.3</p>
<p>60 Shots</p> 	<p>21: 10.3x ↘ 22: 10.3x ↗ 23: 10.3x ↘ 24: 10.5x ↙ 25: 10.0 ↘ 26: 10.1 ↘ 27: 10.6x ↘ 28: 10.3x ↘ 29: 10.2x ↗ 30: 10.6x ↗</p> <p>Series 103.2 308.5</p>	<p>60 Shots</p> 	<p>31: 10.2x ↑ 32: 9.8 → 33: 10.2x ↑ 34: 8.9 → 35: 10.1 ↑ 36: 10.6x → 37: 10.1 ↙ 38: 10.8x ↑ 39: 10.0 ↑ 40: 10.5x ↑</p> <p>Series 101.2 409.7</p>
<p>60 Shots</p> 	<p>41: 10.5x ↗ 42: 10.2x → 43: 10.4x → 44: 10.1 → 45: 10.7x → 46: 10.1 ↑ 47: 10.1 ↙ 48: 10.8x ↑ 49: 10.8x ↗ 50: 10.6x ↘</p> <p>Series 104.3 514.0</p>	<p>60 Shots</p> 	<p>51: 10.3x ↘ 52: 9.9 → 53: 10.2x → 54: 9.6 ← 55: 10.8x ← 56: 10.3x ↑ 57: 10.1 ↘ 58: 10.7x ↗ 59: 9.9 ← 60: 10.8x ↗</p> <p>Series 102.6 616.6</p>

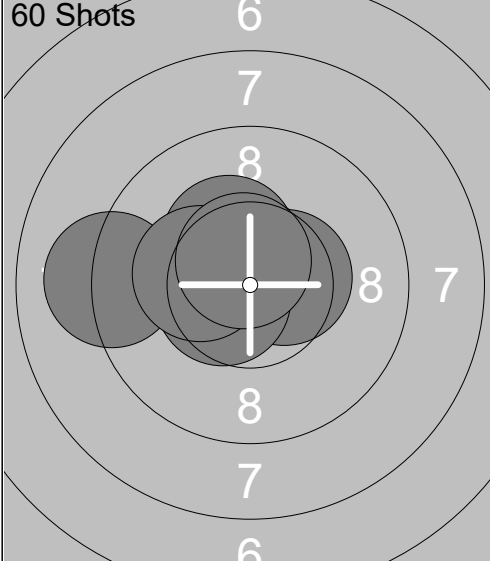
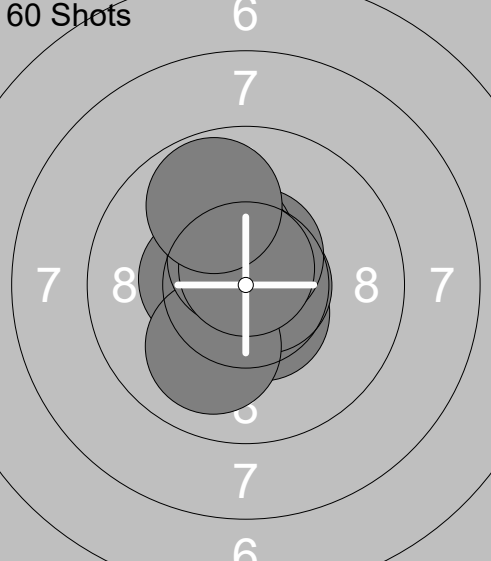
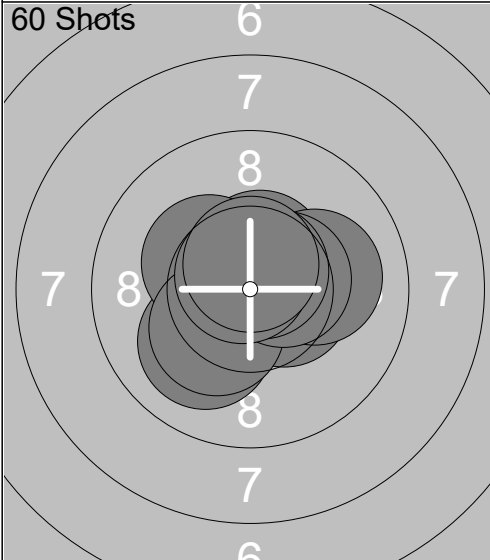
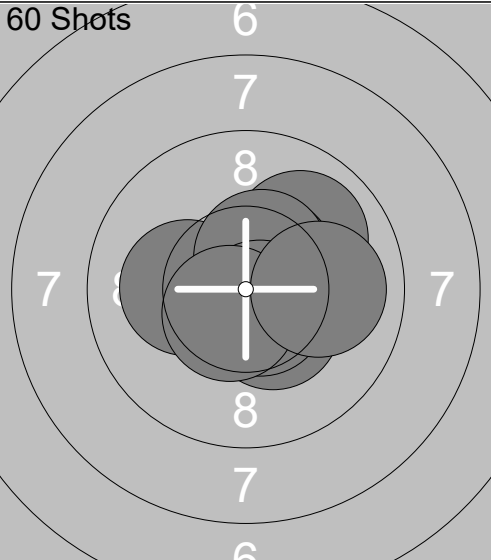
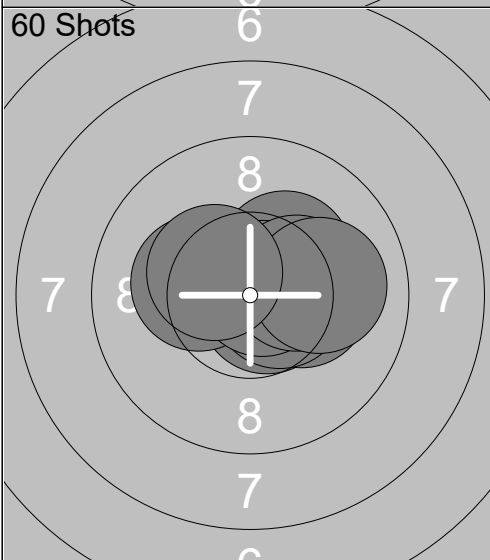
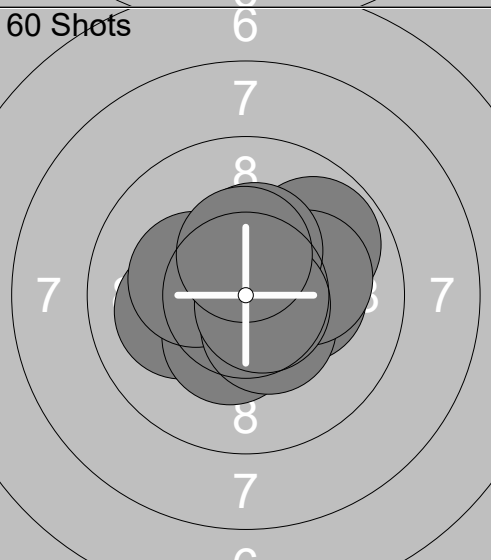
<p>60 Shots</p> 	<p>1: 10.7x ↑ 2: 10.7x ↑ 3: 10.8x ↑ 4: 10.3x ↑ 5: 10.7x ← 6: 9.1 ← 7: 10.5x → 8: 10.6x ← 9: 10.3x ← 10: 10.6x ↑</p> <p>Series 104.3 104.3</p>	<p>60 Shots</p> 	<p>11: 10.6x ↓ 12: 10.5x ↓ 13: 10.7x → 14: 10.5x ↑ 15: 10.3x ↑ 16: 10.4x ← 17: 10.0 ↓ 18: 10.6x ↑ 19: 10.7x ↑ 20: 9.8 ↑</p> <p>Series 104.1 208.4</p>
<p>60 Shots</p> 	<p>21: 10.5x ↑ 22: 10.5x → 23: 10.0 ↓ 24: 10.3x ↖ 25: 10.3x ↓ 26: 10.1 → 27: 10.5x → 28: 10.7x ↑ 29: 10.7x ↑ 30: 10.6x ↑</p> <p>Series 104.2 312.6</p>	<p>60 Shots</p> 	<p>31: 10.4x ↓ 32: 10.0 ↗ 33: 10.1 → 34: 10.7x ← 35: 10.5x ↗ 36: 10.2x ← 37: 10.5x ↑ 38: 10.6x ↓ 39: 10.6x ↓ 40: 10.0 →</p> <p>Series 103.6 416.2</p>
<p>60 Shots</p> 	<p>41: 10.3x ↗ 42: 10.7x ↘ 43: 10.2x ← 44: 10.7x → 45: 10.3x → 46: 10.5x → 47: 10.8x ↗ 48: 10.3x → 49: 10.0 → 50: 10.4x ↖</p> <p>Series 104.2 520.4</p>	<p>60 Shots</p> 	<p>51: 10.1 ← 52: 10.4x ↓ 53: 10.3x → 54: 10.3x ← 55: 10.4x ↓ 56: 9.8 ↗ 57: 10.1 → 58: 10.3x ↑ 59: 10.7x ↘ 60: 10.4x ↑</p> <p>Series 102.8 623.2</p>

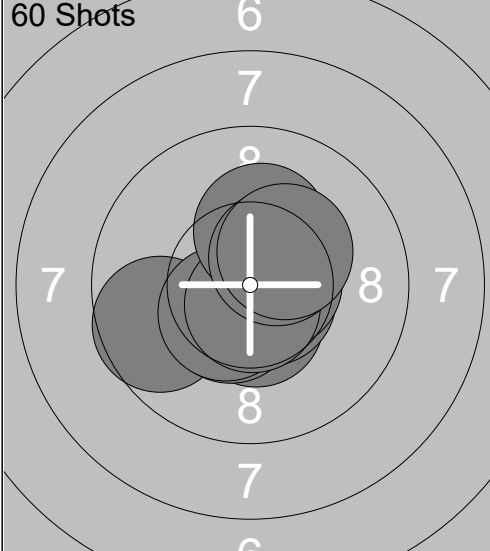
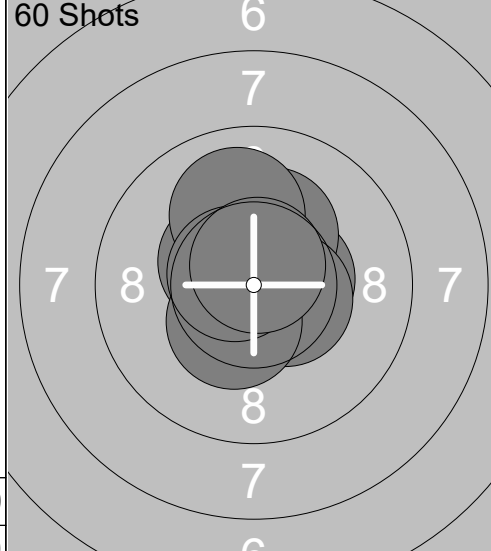
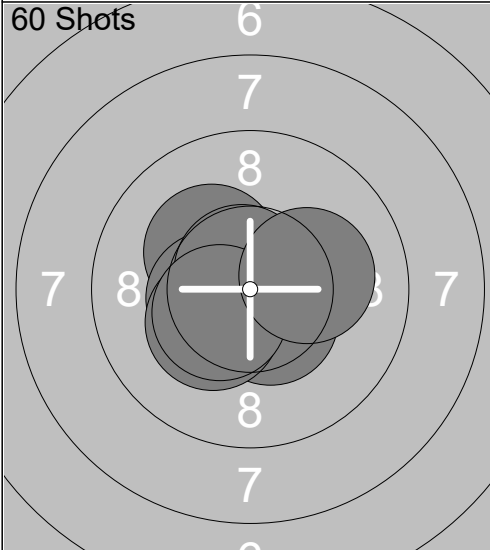
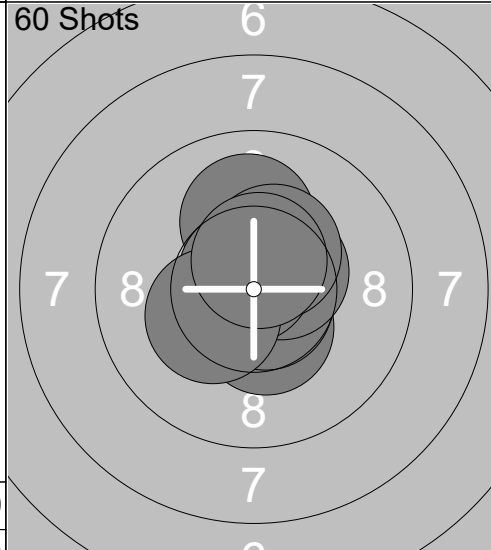
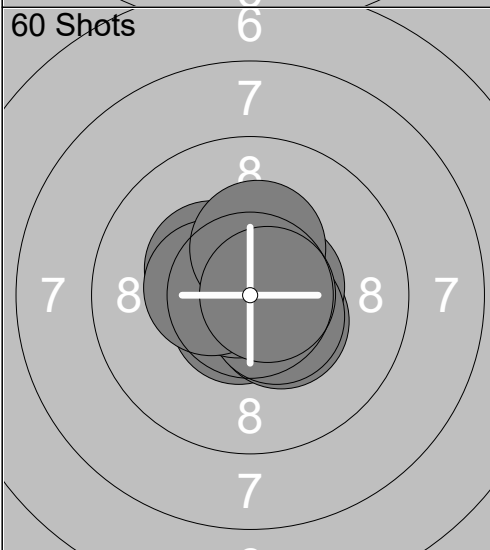
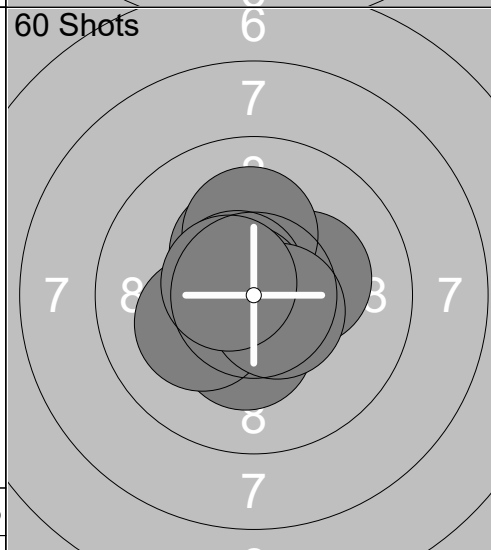
<p>60 Shots</p> 	<p>1: 10.5x ↓ 2: 9.6 ← 3: 10.5x ↓ 4: 10.7x ↘ 5: 10.5x ↓ 6: 10.6x → 7: 10.7x ↓ 8: 10.2x ↑ 9: 10.4x ↗ 10: 10.3x ↗</p> <p>Series 104.0 104.0</p>	<p>60 Shots</p> 	<p>11: 10.5x ↑ 12: 10.5x → 13: 10.5x ↖ 14: 10.9x ↓ 15: 10.3x ↑ 16: 10.0 ↑ 17: 10.5x → 18: 10.4x ↓ 19: 10.7x ↖ 20: 10.7x ↑</p> <p>Series 105.0 209.0</p>
<p>60 Shots</p> 	<p>21: 10.8x → 22: 10.6x ↓ 23: 10.2x ↗ 24: 10.7x ↓ 25: 10.5x ↓ 26: 10.5x ← 27: 10.3x ↓ 28: 10.7x ↑ 29: 10.4x ↓ 30: 10.2x →</p> <p>Series 104.9 313.9</p>	<p>60 Shots</p> 	<p>31: 10.4x ↓ 32: 10.4x ↑ 33: 10.9x ↖ 34: 10.7x ↘ 35: 10.5x ↗ 36: 10.1 ↑ 37: 10.7x ↖ 38: 10.3x ↖ 39: 10.4x ↑ 40: 10.6x ↑</p> <p>Series 105.0 418.9</p>
<p>60 Shots</p> 	<p>41: 10.7x ↑ 42: 10.6x ↓ 43: 10.4x ↘ 44: 10.6x → 45: 10.5x ↘ 46: 10.8x ↖ 47: 10.3x ↖ 48: 10.4x ← 49: 10.3x ↑ 50: 10.7x →</p> <p>Series 105.3 524.2</p>	<p>60 Shots</p> 	<p>51: 10.3x ↓ 52: 10.8x ↑ 53: 10.4x ↑ 54: 10.3x → 55: 10.1 ↑ 56: 10.6x ↖ 57: 10.8x ↖ 58: 10.2x ↖ 59: 10.6x ↘ 60: 10.6x ↖</p> <p>Series 104.7 628.9</p>

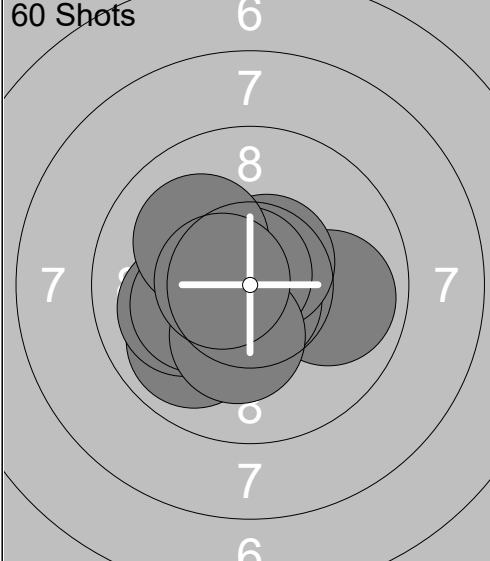
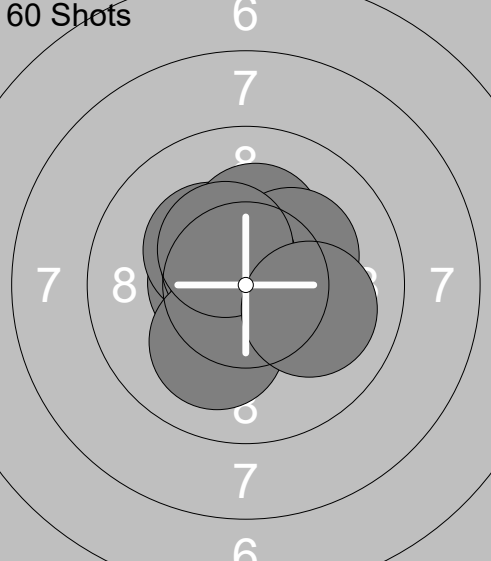
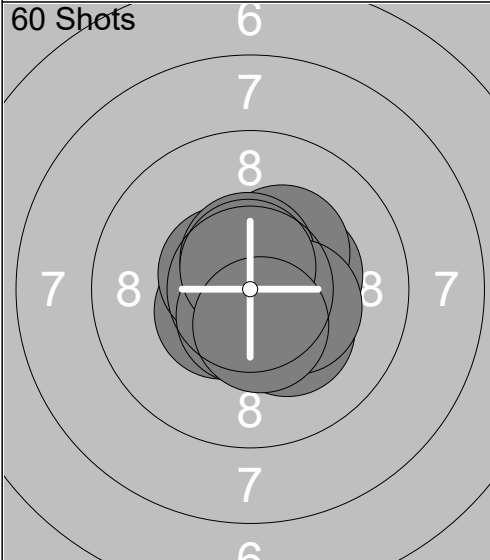
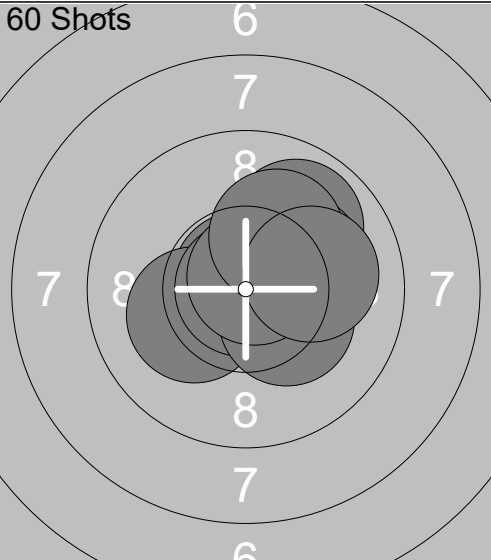
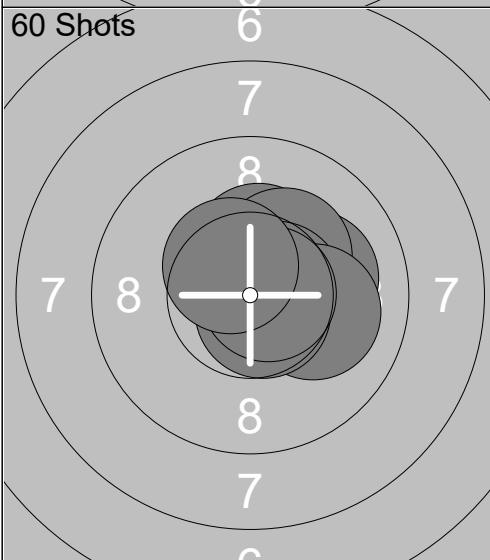
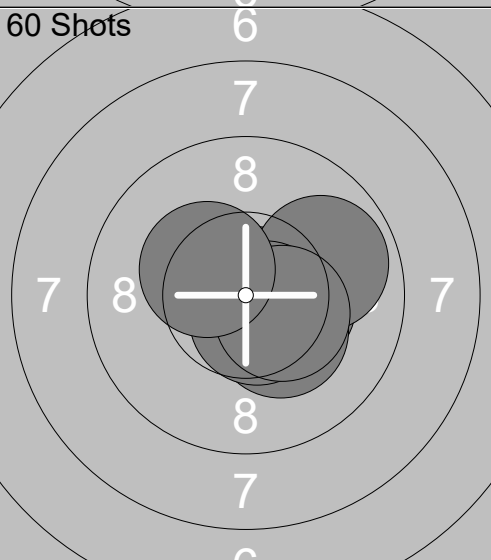
<p>60 Shots</p> 	<p>1: 9.9 →</p> <p>2: 9.9 ↙</p> <p>3: 10.0 ←</p> <p>4: 10.7x ↓</p> <p>5: 10.6x ↗</p> <p>6: 10.2x ←</p> <p>7: 10.8x ↗</p> <p>8: 10.3x ↓</p> <p>9: 10.1 ↖</p> <p>10: 10.6x ←</p>	<p>60 Shots</p> 	<p>11: 10.5x ←</p> <p>12: 10.3x ↖</p> <p>13: 10.2x ↑</p> <p>14: 10.8x ↘</p> <p>15: 10.2x ↗</p> <p>16: 10.6x ↖</p> <p>17: 10.8x ↓</p> <p>18: 10.1 ↓</p> <p>19: 10.4x ↗</p> <p>20: 10.1 →</p>
	Series 103.1		Series 104.0
	103.1		207.1
<p>60 Shots</p> 	<p>21: 10.5x ↙</p> <p>22: 10.3x →</p> <p>23: 10.6x ↖</p> <p>24: 10.3x ↗</p> <p>25: 10.6x ↑</p> <p>26: 10.2x ↘</p> <p>27: 10.6x ↓</p> <p>28: 10.3x →</p> <p>29: 10.7x ↑</p> <p>30: 10.5x ↓</p>	<p>60 Shots</p> 	<p>31: 9.9 ↗</p> <p>32: 10.8x ↖</p> <p>33: 10.2x ↗</p> <p>34: 10.2x ←</p> <p>35: 10.6x →</p> <p>36: 10.9x ←</p> <p>37: 10.3x ↘</p> <p>38: 10.8x ↗</p> <p>39: 10.1 ↗</p> <p>40: 10.1 →</p>
	Series 104.6		Series 103.9
	311.7		415.6
<p>60 Shots</p> 	<p>41: 10.1 →</p> <p>42: 10.8x →</p> <p>43: 10.5x ↗</p> <p>44: 10.4x ↑</p> <p>45: 10.3x ↗</p> <p>46: 10.6x →</p> <p>47: 10.1 →</p> <p>48: 10.7x ↘</p> <p>49: 10.7x →</p> <p>50: 10.5x ↖</p>	<p>60 Shots</p> 	<p>51: 10.8x →</p> <p>52: 10.4x →</p> <p>53: 10.5x ↓</p> <p>54: 9.9 →</p> <p>55: 10.4x ↘</p> <p>56: 10.6x ↘</p> <p>57: 10.3x ↘</p> <p>58: 10.6x ↓</p> <p>59: 10.4x ↘</p> <p>60: 10.3x ↖</p>
	Series 104.7		Series 104.2
	520.3		624.5

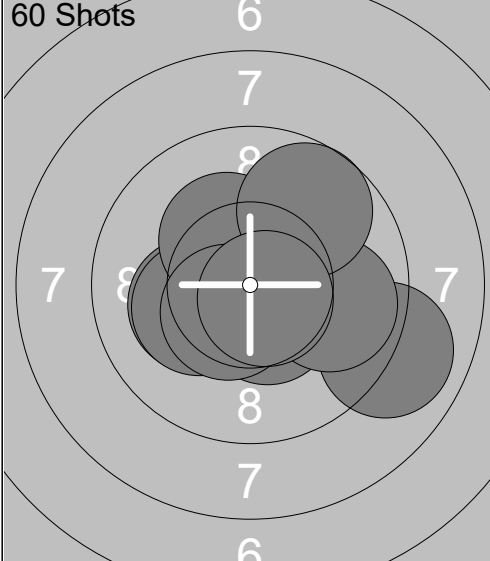
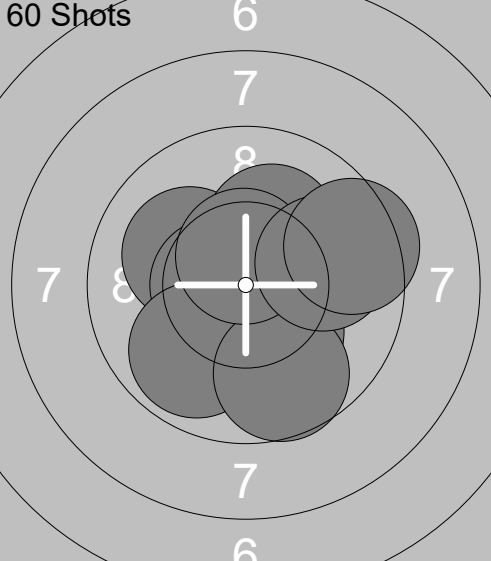
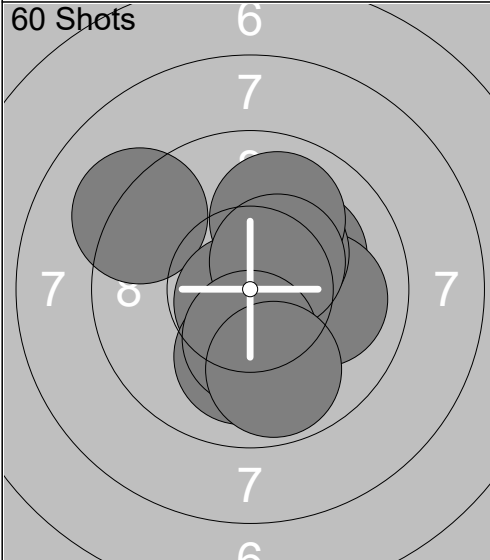
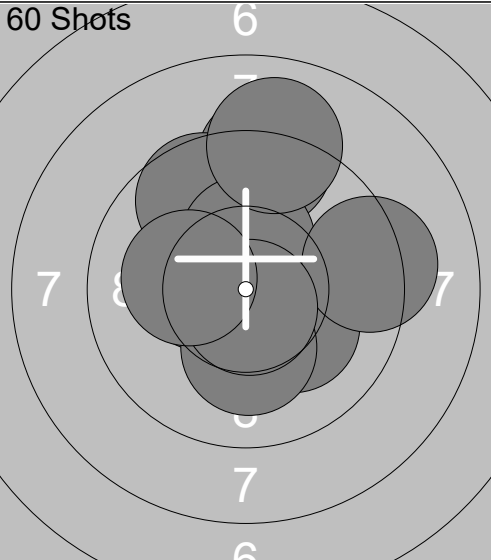
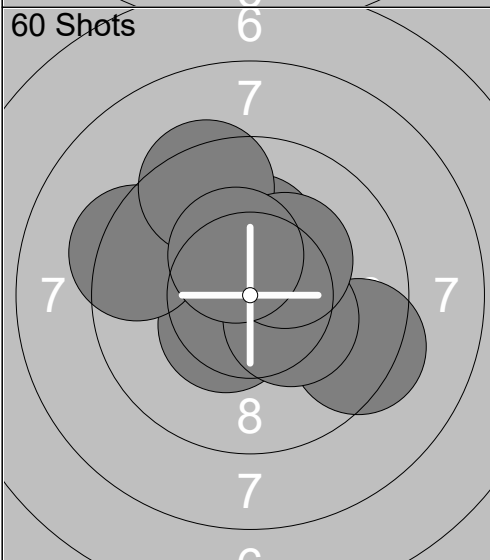
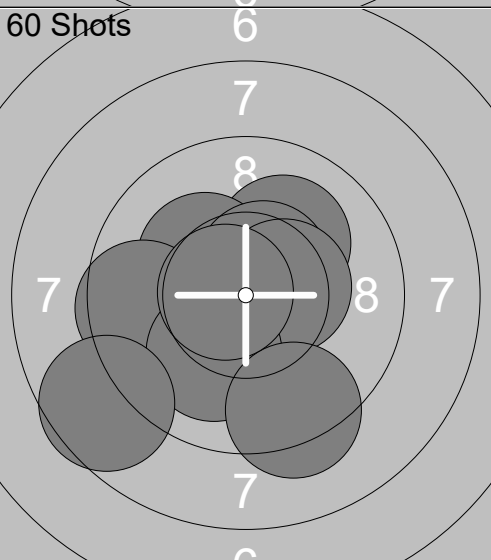
<p>60 Shots</p> 	<p>1: 9.0 ➤ 2: 10.5x ▼ 3: 10.3x ↗ 4: 10.2x ← 5: 10.2x ← 6: 10.3x ↗ 7: 9.9 ➤ 8: 9.7 ↗ 9: 10.5x ▼ 10: 10.7x ▼</p> <p>Series 101.3 101.3</p>	<p>60 Shots</p> 	<p>11: 10.1 ← 12: 10.2x ↗ 13: 10.6x ← 14: 10.3x ▼ 15: 10.2x ▼ 16: 9.9 ▼ 17: 9.7 ▼ 18: 10.6x ↗ 19: 9.9 ➤ 20: 9.5 ➤</p> <p>Series 101.0 202.3</p>
<p>60 Shots</p> 	<p>21: 10.2x ↗ 22: 9.2 ← 23: 10.8x ▼ 24: 10.0 ➤ 25: 10.3x ↗ 26: 10.0 ↗ 27: 10.4x ↗ 28: 10.0 ▼ 29: 10.3x ▼ 30: 9.8 ▼</p> <p>Series 101.0 303.3</p>	<p>60 Shots</p> 	<p>31: 10.2x ➤ 32: 9.2 ↗ 33: 9.7 ↗ 34: 10.4x ← 35: 10.3x ↗ 36: 9.3 ➤ 37: 9.0 ↗ 38: 10.2x ▼ 39: 10.7x ▼ 40: 10.2x ←</p> <p>Series 99.2 402.5</p>
<p>60 Shots</p> 	<p>41: 10.5x ↗ 42: 10.2x ↗ 43: 10.4x ➤ 44: 10.4x ▼ 45: 9.4 ➤ 46: 9.3 ← 47: 10.3x ➤ 48: 9.4 ↗ 49: 10.3x ↗ 50: 10.4x ↗</p> <p>Series 100.6 503.1</p>	<p>60 Shots</p> 	<p>51: 10.6x ➤ 52: 10.1 ↗ 53: 10.2x ← 54: 10.5x ↗ 55: 10.4x ➤ 56: 9.6 ← 57: 10.1 ▼ 58: 8.6 ← 59: 9.3 ▼ 60: 10.7x ←</p> <p>Series 100.1 603.2</p>

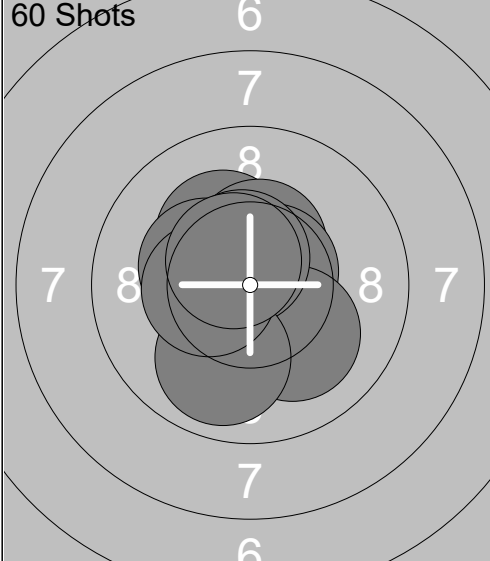
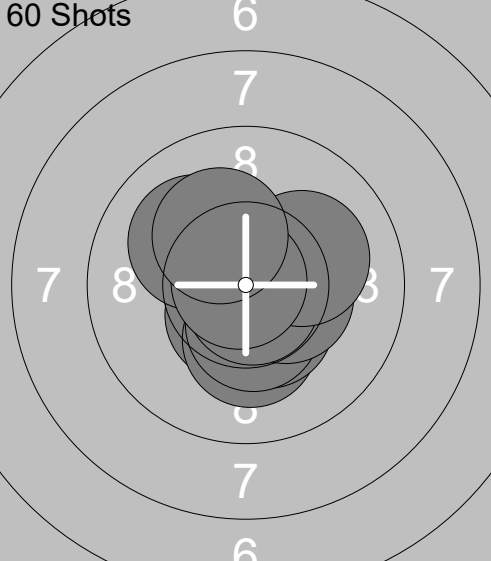
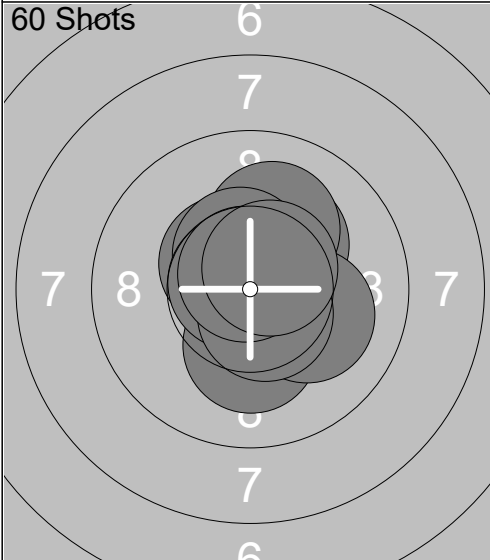
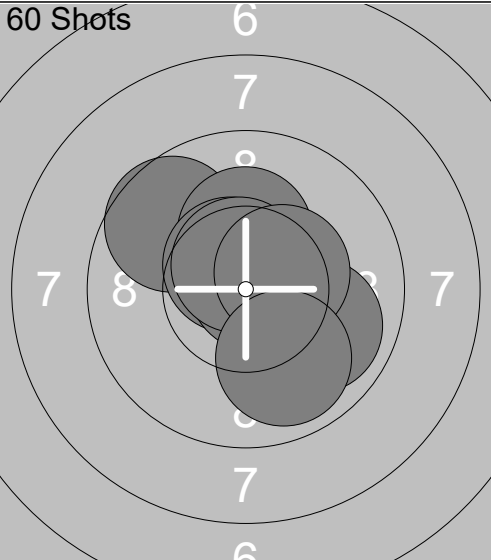
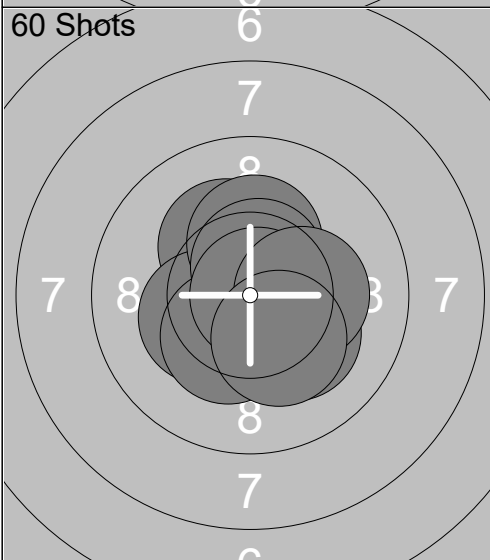
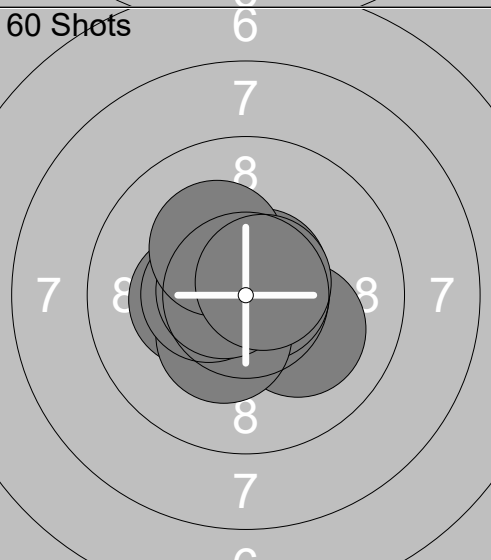
<p>60 Shots</p> 	<p>1: 10.2x ↗ 2: 10.4x ↑ 3: 10.6x ↓ 4: 10.6x ↗ 5: 10.1 ↓ 6: 10.3x ↖ 7: 10.6x ↑ 8: 9.9 ↓ 9: 10.4x ← 10: 10.6x ↗</p> <p>Series 103.7 103.7</p>	<p>60 Shots</p> 	<p>11: 10.5x ↓ 12: 10.2x ↓ 13: 10.4x ↓ 14: 10.1 ↗ 15: 10.4x ↓ 16: 10.4x ⇒ 17: 10.8x ↓ 18: 10.1 ↗ 19: 10.8x ↖ 20: 10.2x ↗</p> <p>Series 103.9 207.6</p>
<p>60 Shots</p> 	<p>21: 10.5x ↗ 22: 10.2x ↗ 23: 10.1 ↑ 24: 10.2x ↓ 25: 10.5x ↑ 26: 10.1 ⇒ 27: 10.7x ↖ 28: 10.6x ↓ 29: 10.7x ↑ 30: 10.6x ↗</p> <p>Series 104.2 311.8</p>	<p>60 Shots</p> 	<p>31: 9.6 ↖ 32: 10.2x ⇒ 33: 10.5x ↑ 34: 10.2x ↑ 35: 10.6x ↗ 36: 9.9 ⇒ 37: 10.8x ↗ 38: 10.6x ↑ 39: 10.4x ↗ 40: 9.9 ↓</p> <p>Series 102.7 414.5</p>
<p>60 Shots</p> 	<p>41: 10.2x ↗ 42: 10.3x ↖ 43: 10.3x ↑ 44: 10.3x ⇒ 45: 10.3x ↓ 46: 10.6x ↑ 47: 10.9x ⇒ 48: 10.2x ↓ 49: 10.3x ⇒ 50: 10.3x ↓</p> <p>Series 103.7 518.2</p>	<p>60 Shots</p> 	<p>51: 10.7x ↗ 52: 10.1 ⇒ 53: 10.3x ← 54: 10.7x ⇒ 55: 10.3x ↓ 56: 10.5x ← 57: 10.6x ↗ 58: 10.7x ← 59: 10.2x ↗ 60: 10.7x ↗</p> <p>Series 104.8 623.0</p>